

# Chaos Control in a Non-Isothermal Autocatalytic Chemical Reactor

**Rasoulian, Shabnam; Shahrokhi, Mohammad\*<sup>+</sup>**

*Department of Chemical and Petroleum Engineering, Sharif University of Technology,  
P.O. Box 11365-9465 Tehran, I.R. IRAN*

**Salarieh, Hassan**

*Department of Mechanical Engineering, Sharif University of Technology, P.O. Box 11365-9567 Tehran, I.R. IRAN*

**ABSTRACT:** *In this paper, a reaction system consisting of two parallel, non-isothermal autocatalytic reactions in a Continuous Stirred Tank Reactor (CSTR) has been considered. Reactor chaotic behavior is possible for a certain values of system parameters. Two types of controllers are designed and compared in order to control both the reactor temperature and the product concentration. The first controller is a linear state feedback type, designed based on the linearized model of the process and the second one is designed based on the Global Linearizing Control (GLC) strategy. Since the system states are not measured completely, a nonlinear observer has been used to estimate the system states. Finally, computer simulation is performed to show the effectiveness of the proposed schemes. Simulation results indicate that the GLC-based control scheme is more effective for set point tracking, while the control scheme obtained using the linearized model of the process is more efficient for load rejection purposes.*

**KEY WORDS:** *Chaos control, Autocatalytic reaction, Input-output linearization, Observer.*

## INTRODUCTION

The complicated phenomena observed in chemical systems ranged from multiple steady states to simple oscillations, and chaos. Autocatalytic reactions taking place in an isothermal CSTR provide one of the simplest systems for bifurcation studies. The two-reaction model (cubic autocatalysis and catalyst decay) has been studied extensively by *Scott et al.* [1-3]. *Lynch et al.* demonstrated the existence of chaotic behavior for two parallel exothermic reactions [4]. The existence of chaotic behavior in isothermal reactors with autocatalytic reactions has also been investigated in [5-7]. Also, it is shown that

by periodic forcing of the feed flow rate, the chaotic behavior of the autocatalytic reactor can be controlled for even small forcing amplitude or frequencies [8]. Externally forced chemical reactors have also been examined in a number of studies [9, 10]. Self-oscillation, saddle-focus bifurcation and chaotic behavior of a PI-controlled CSTR have been investigated in [11, 12].

In addition, *Elnashaie et al.* investigated the occurrence of chaos in a fluidized bed catalytic reactor with consecutive exothermic chemical reactions [13]. *Teymour & Ray* showed that chaos can occur

---

\* To whom correspondence should be addressed.

+ E-mail: shahrokhi@sharif.edu

1021-9986/14/4/89

9/\$2.90

in a polymerization reactor [14]. As far as control is concerned; chaos control was initiated by the pioneering work of *Ott et al.*, in which a feedback control is applied to stabilize chaos in the Poincare map whose method is called OGY [15]. In addition, it has been found that a fuzzy control system constructed on OGY algorithm can result in smaller control transient response [16]. *Salarieh & Shahrokhi* designed an indirect adaptive controller to stabilize chaotic systems with unknown parameters [17]. Adaptive control of chaos in noisy environment was investigated by *Salarieh & Alasty* [18]. One of the probabilistic features of a chaotic motion is entropy which is based on the probability invariant measure of chaos in its strange attractor. Consequently, minimizing the entropy function can be considered as an approach to design a stabilizing controller [19, 20]. Chaos control in a CSTR has been investigated by several researches in [11, 12, 21].

In this paper, control of an autocatalytic non-isothermal CSTR has been considered. To control the chaotic dynamics, two distinct control schemes are designed. The control objective is controlling reactor temperature and product concentration. The first controller is a linear state feedback type, while the second one is designed based on the GLC strategy. For implementation of the designed model based controllers, an observer has been utilized. The effectiveness of the proposed controllers in load rejection and set point tracking has also been demonstrated through computer simulation.

## THEORITICAL SECTION

### Reaction kinetics

One of the autocatalytic reaction systems which can have chaotic behavior is based on two parallel cubic autocatalysis reactions with catalyst decay [5-7]. In order to make the process more realistic, we have assumed that these reactions are taking place in a non-isothermal reactor. The reactor is equipped with a jacket for reactor temperature control. The reactions rates,  $r_A$ ,  $r_B$  and  $r_D$ , are given by Eqs.(1)-(3).

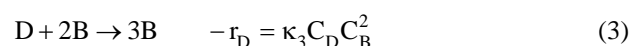
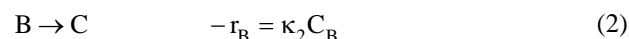

Where  $\kappa_i = k_i \exp(-E_i/RT)$ ,  $i = 1, 2, 3$ , and  $C_i$  and  $E_i$  denote the concentration of the  $i$ th component and activation energy of the  $i$ th reaction, respectively.

The symbols  $R$  and  $T$  are the universal gas constant, and the reactor temperature, respectively.

Using the above reaction kinetics and energy balances on the reactor and its jacket, the reactor model can be presented in the dimensionless form as follows [21].

$$\frac{dx_1}{d\tau} = \gamma_1 - x_1 - Da_1 x_1 x_3^2 e^{-\varphi(\frac{1}{x_4}-1)} \quad (4)$$

$$\frac{dx_2}{d\tau} = \gamma_2 - x_2 - Da_2 x_2 x_3^2 e^{-\varphi\alpha_2(\frac{1}{x_4}-1)} \quad (5)$$

$$\frac{dx_3}{d\tau} = \gamma_3 - x_3 + Da_1 x_1 x_3^2 e^{-\varphi(\frac{1}{x_4}-1)} - \quad (6)$$

$$Da_3 x_3 e^{-\varphi\alpha_1(\frac{1}{x_4}-1)} + Da_2 x_2 x_3^2 e^{-\varphi\alpha_2(\frac{1}{x_4}-1)}$$

$$\frac{dx_4}{d\tau} = \xi - x_4 + R'_H(x_1, x_2, x_3, x_4) + U_1(x_5 - x_4) \quad (7)$$

$$\frac{dx_5}{d\tau} = \varepsilon(U_2(x_4 - x_5) + \psi - x_5) \quad (8)$$

$$\text{where } R'_H(x_1, x_2, x_3, x_4) = \eta Da_1 x_1 x_3^2 e^{-\varphi(\frac{1}{x_4}-1)} + \beta_1 \eta Da_3 x_3 e^{-\varphi\alpha_1(\frac{1}{x_4}-1)} + \beta_2 \eta Da_2 x_2 x_3^2 e^{-\varphi\alpha_2(\frac{1}{x_4}-1)}$$

The state variables  $x_1, x_2, x_3$  are dimensionless concentrations, and  $x_4$  and  $x_5$  are the reactor and jacket dimensionless temperatures.

For the following set of parameters the reactor shows chaotic behavior [21]:  $\varphi=8, \alpha_1=0.8, \alpha_2=1.1, \eta=0.375, \beta_1=0.69, \beta_2=-0.37, \gamma_1=1.5, \gamma_2=4.2, \gamma_3=1, Da_1=5483.8, Da_2=108.206, Da_3=30.913, U_1=200, U_2=27, \xi=1, \psi=1, \varepsilon=1$ .

Evaluation of Lyapunov exponents is the one of the most useful methods to recognize chaotic systems because positive Lyapunov exponents indicate chaotic dynamics. The technique presented by *Wolf et al.* has been utilized to determine the Lyapunov exponents [22]. In this system, Lyapunov exponents are as follows: {1.48, 0, -1, -51, -8} indicating chaotic dynamics [21].

System equilibrium point is as follows,  $x_e = (x_{1e}, x_{2e}, x_{3e}, x_{4e}, x_{5e}) = (0.0222, 1.6892, 0.0595, 1.1819, 1.1754)$ . The eigenvalues of the linearized system around its equilibrium point are as follows:  $\lambda_1 = -221.4, \lambda_2 = -27.6, \lambda_{3,4} = 3.98 \pm 17.7i, \lambda_5 = -1$  indicating that the process is unstable around the equilibrium point.

Control of a chaotic CSTR is quite challenging due to the system embedded unstable periodic orbits and their tendency to thermal runaway.

### Controller design

The reactor considered in this paper, can show chaotic behavior in both isothermal and non-isothermal conditions. The main objective is controlling the product concentration, but for the safety reason the reactor temperature should be also controlled.

In this paper, concentration of product B and the reactor temperature are controlled via manipulating the concentration of B in the feed and the inlet jacket temperature. The system equations 4-8 can be written in the standard state space form as follows [21]:

$$\dot{x} = f(x) + \sum_{j=1}^2 g_j(x) u_j \quad (9-a)$$

$$y_i = h_i(x), \quad i = 1, 2. \quad (9-b)$$

where,

$$x^T = (x_1, x_2, x_3, x_4, x_5) \quad (10)$$

$$f(x) = \begin{pmatrix} \gamma_1 - x_1 - Da_1 x_1 x_3^2 e^{(-\varphi(\frac{1}{x_4}-1))} \\ \gamma_2 - x_2 - Da_2 x_2 x_3^2 e^{(-\varphi\alpha_2(\frac{1}{x_4}-1))} \\ -x_3 + Da_1 x_1 x_3^2 e^{(-\varphi(\frac{1}{x_4}-1))} - Da_3 x_3 e^{(-\varphi\alpha_1(\frac{1}{x_4}-1))} + \\ Da_2 x_2 x_3^2 e^{(-\varphi\alpha_2(\frac{1}{x_4}-1))} \\ \xi - x_4 + R'_H(x_1, x_2, x_3, x_4) + U_1(x_5 - x_4) \\ \varepsilon(U_2(x_4 - x_5) - x_5) \end{pmatrix}$$

$$g_1(x) = (0 \ 0 \ 1 \ 0 \ 0)^T, \quad g_2(x) = (0 \ 0 \ 0 \ 1 \ 0)^T$$

$$h_1(x) = x_3, \quad h_2(x) = x_4, \quad u_1 = \gamma_3, \quad u_2 = \psi$$

In what follows two controllers will be considered, the first one is designed based on the LQR technique using the linearized process model, while the second one is an input-output linearizing controller.

### Linearized process model

In this section, first the process model is linearized and then, a linear state feedback controller based on the LQR technique is designed. The linearized process model around the equilibrium point is as follows:

$$\dot{x} = Ax + \sum_{j=1}^2 B_j u_j \quad (11)$$

where [18],

$$A = \left( \frac{\partial f}{\partial x} \right) \Big|_{x=x_e} =, \quad (12)$$

$$\begin{pmatrix} -67.5 & 0 & -49.6252 & -8.455 & 0 \\ 0 & -2.484 & -84.2696 & -15.79 & 0 \\ 66.5 & 1.4841 & 50.117 & 1.6829 & 0 \\ 24.9 & -0.206 & 28.3358 & -194.18 & 200 \\ 0 & 0 & 0 & 27 & -28 \end{pmatrix}$$

$$B_1 = \left( \frac{\partial g_1}{\partial x} \right) \Big|_{x=x_e} = (0 \ 0 \ 1 \ 0 \ 0)^T, \quad B_2 =$$

$$\left( \frac{\partial g_2}{\partial x} \right) \Big|_{x=x_e} = (0 \ 0 \ 0 \ 0 \ 1)^T$$

Then the system has been transformed into an augmented form by introducing two new variables:

$$x_6 = \int_0^t (x_3 - x_{3, \text{set point}}) dt, \quad x_7 = \int_0^t (x_4 - x_{4, \text{set point}}) dt$$

This leads to a controller possessing integral actions on the third and fourth states. The augmented system is given below.

$$\dot{x}' = A'x' + \sum_{j=1}^2 B'_j u_j$$

$$x'^T = (x_1, x_2, x_3, x_4, x_5, \int_0^t (x_3 - x_{3, \text{set point}}) dt,$$

$$\int_0^t (x_4 - x_{4, \text{set point}}) dt)$$

$$A' = \quad (13)$$

$$\begin{pmatrix} -67.5 & 0 & -49.6252 & -8.455 & 0 & 0 & 0 \\ 0 & -2.484 & -84.2696 & -15.79 & 0 & 0 & 0 \\ 66.5 & 1.4841 & 50.117 & 1.6829 & 0 & 0 & 0 \\ 24.9 & -0.206 & 28.3358 & -194.18 & 200 & 0 & 0 \\ 0 & 0 & 0 & 27 & -28 & 0 & 0 \\ 0 & 0 & 1 & 0 & 0 & 0 & 0 \\ 0 & 0 & 0 & 1 & 0 & 0 & 0 \end{pmatrix}$$

$$B'_1 = (0 \ 0 \ 1 \ 0 \ 0 \ 0 \ 0)^T,$$

$$B'_2 = (0 \ 0 \ 0 \ 0 \ 1 \ 0 \ 0)^T$$

State feedback gain calculation has been performed using the Riccati equation based on a LQR problem. For this purpose the following objective function has been considered:

$$J = \int_0^{\infty} (x'^T R_x x' + u^T R_u u) dt \quad (14)$$

Where  $R_x$  is a positive semi-definite matrix and  $R_u$  is a positive definite matrix. The optimal input is  $u = -R_u^{-1} B^T P' x'$ , where  $P'$  is evaluated via Eq.(15), called the Riccati equation.

$$A'^T P' + P' A' - P' B' B'^T P' + R_x = 0 \quad (15)$$

#### Global linearizing control

In this section, an MIMO (Multi-Input Multi-Output) controller based on input-output linearization technique is designed. Design of feedback linearizing controller and nonlinear inversion for MIMO systems can be found in [23,24].

The zero dynamics of the considered system is stable. For such a system the non-singularity of the characteristic matrix and existence of finite relative order for each output are sufficient conditions for input/output linearization to be achievable through static state feedback. Based on the model provided by Eq.(10), the relative orders of this system are obtained as follows:

$$L_{g_1} h_1(x) = 1, \quad L_{g_2} h_2(x) = 0$$

$$L_f h_2(x) = \zeta - x_4 + B D a_1 x_1 x_3^2 e^{\left(\frac{-\varphi}{x_4}\right)} + \beta_1 B D a_3 x_3 e^{\left(\frac{-\varphi \alpha_1}{x_4}\right)} +$$

$$\beta_2 B D a_2 x_2 x_3^2 e^{\left(\frac{-\varphi \alpha_2}{x_4}\right)} + U_1 (x_5 - x_4)$$

$$L_{g_2} L_f h_2(x) = U_1$$

Where  $L_{g_i}$ , and  $L_f$  are the Lie derivatives with respect to  $g_i$  and  $f$  functions, respectively. Therefore, for this system relative orders are as follows:

$$r_1 = 1, r_2 = 2 \quad (16)$$

Moreover, the characteristic matrix, which is defined below, is nonsingular.

$$C(x) = \begin{pmatrix} L_{g_1} h_1(x) & L_{g_2} h_1(x) \\ L_{g_1} L_f h_2(x) & L_{g_2} L_f h_2(x) \end{pmatrix} = \quad (17)$$

$$\begin{pmatrix} 1 & 0 \\ L_{g_1} L_f h_2(x) & U_1 \end{pmatrix}, \quad \det(C(x)) \neq 0$$

To determine the zero dynamics, the original system can be transformed into a normal form using transformation matrix given by Eq.(18).

$$\zeta = \begin{pmatrix} \zeta_1^{(0)} \\ \zeta_2^{(0)} \\ \zeta_1^{(1)} \\ \zeta_1^{(2)} \\ \zeta_2^{(2)} \end{pmatrix} = \begin{pmatrix} t_1(x) \\ t_2(x) \\ h_1(x) \\ h_2(x) \\ L_f h_2(x) \end{pmatrix} = \begin{pmatrix} x_1 \\ x_2 \\ x_3 \\ x_4 \\ L_f h_2(x) \end{pmatrix} \quad (18)$$

In the above equation,  $t_1(x)$  and  $t_2(x)$  are scalar fields such that the scalar fields  $t_1(x)$ ,  $t_2(x)$ ,  $h_1(x)$ ,  $h_2(x)$ ,  $L_f h_2(x)$  are linearly independent and an obvious choice for these two scalar fields is  $t_1(x)=x_1$ ,  $t_2(x)=x_2$ . Variables of Eq.(18) makes a normal form for the system described by Eq.(10). Its first two states denoted by superscript (0), form a nonlinear subsystem which will be associated with the zero dynamics of the main system. Other states denoted by superscripts (1) and (2), constitute two other subsystems of Eq. (10). Indeed Eq. (10) can be represented in the normal form using the state variables defined by Eq. (18). For the nonlinear system of Eq.(10), the unforced zero dynamics is given in Eq.(19).

$$\dot{\zeta}_1^{(0)} = \gamma_1 - \zeta_1^{(0)} - D a_1 \zeta_1^{(0)} (x_{3ss})^2 e^{-\phi \left(\frac{1}{x_{4ss}} - 1\right)} \quad (19)$$

$$\dot{\zeta}_2^{(0)} = \gamma_2 - \zeta_2^{(0)} - D a_2 \zeta_2^{(0)} (x_{3ss})^2 e^{-\phi \alpha_2 \left(\frac{1}{x_{4ss}} - 1\right)}$$

For stability analysis, local results can be obtained through checking the eigenvalues of the linear approximation of the unforced zero dynamics of Eq.(19), around the equilibrium point. Owing to negative eigenvalues which are  $\{-67.6051, -2.4864\}$ , the closed loop system is locally internally stable and the input/output linearization technique can be applied for tracking control. The control law of Eq.(20) leads to a linear closed loop input/output system.

$$\begin{pmatrix} u_1 \\ u_2 \end{pmatrix} = \begin{pmatrix} \beta_{11} L_{g_1} h_1(x) & \beta_{11} L_{g_2} h_1(x) \\ \beta_{22} L_{g_1} L_f h_2(x) & \beta_{22} L_{g_2} L_f h_2(x) \end{pmatrix}^{-1} \times \quad (20)$$

$$\begin{pmatrix} v_1 \\ v_2 \end{pmatrix} = \begin{pmatrix} \beta_{10} h_1(x) + \beta_{11} L_f h_1(x) \\ \beta_{20} h_2(x) + \beta_{21} L_f h_2(x) + \beta_{22} L_f^2 h_2(x) \end{pmatrix}$$

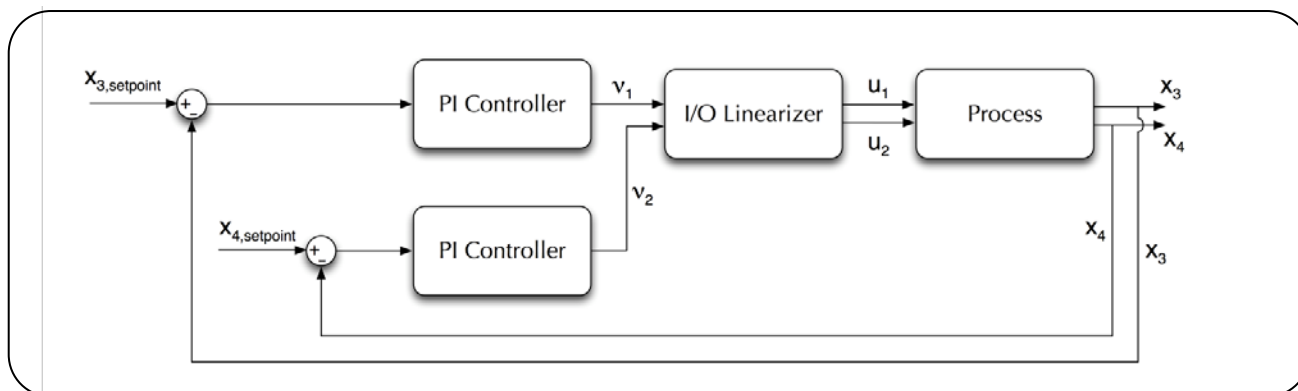

Fig. 1: Block diagram for the control scheme based on I/O linearization.

In Eq.(20)  $\beta_{ik}$ 's are scalar tuning parameters. Dynamics of the resulting  $v-y$  system, after applying the above mentioned controller is described by Eq.(21).

$$\begin{cases} \beta_{10}y_1 + \beta_{11}\frac{dy_1}{dt} = v_1 \\ \beta_{20}y_2 + \beta_{21}\frac{dy_2}{dt} + \beta_{22}\frac{d^2y_2}{dt^2} = v_2 \end{cases} \quad (21)$$

Where  $v_1$  and  $v_2$  are determined such that the linearized input/output dynamics of Eq. (21) shows the desired behavior for the output states  $y_1$  and  $y_2$ . For the linearized system, two PI controllers are used to generate  $v_1$  and  $v_2$  signals. The block diagram illustrating I/O linearizing control scheme is presented in Fig. 1.

### Observer design

From the practical point of view, in most applications all the system states are not available but on the other hand for applying the state feedback controller, the system states are required. Therefore, using an observer for estimating the unavailable states is unavoidable. For this reactor, it is assumed that only the reactor temperature is available and other states are estimated using an observer. The Thau observer can be used for this purpose.

To perform the estimation, a nonlinear full order observer is used. Consider the following system,

$$\dot{\hat{x}} = f(\hat{x}) + Bu + K(Y - \hat{Y}) \quad (22-a)$$

$$\hat{Y} = C\hat{x} \quad (22b)$$

Where  $f$  is given by Eq. (10) and  $K$  is the observer gain which can be obtained by the method presented in [21].

The local asymptotic stability of the above observer can be established as shown in [21, 25].

In presence of unmeasured disturbances, the above mentioned observer can be extended to estimate the disturbances together with the state estimates. To accomplish this, the modeled disturbance is appended as augmented state to the original system model. If  $\gamma_1$  is considered as the common disturbance acting on the process, then the following observer is obtained:

$$\dot{\hat{x}}_a = f_a(\hat{x}_a) + B_a u + K_a (Y - \hat{Y}) \quad (23-a)$$

$$\hat{Y} = C_a \hat{x}_a \quad (23-b)$$

where,

$$\hat{x}_a^T = (x_1, x_2, x_3, x_4, x_5, \gamma_1)$$

$$f_a(\hat{x}_a) = \begin{pmatrix} f(\hat{x}) \\ 0 \end{pmatrix}$$

$$B_a = \begin{pmatrix} B \\ 0 \end{pmatrix}$$

$$C_a = (0 \ 0 \ 0 \ 1 \ 0 \ 0)$$

### Simulation results

In this section, simulation results are presented with systems initial condition  $[x_{10}, x_{20}, x_{30}, x_{40}, x_{50}]^T = [0.03, 1.8, 0.05, 1.1, 1.1]^T$ . From the practical standpoint, limitations on controller actions must be taken into account, hence in simulation, input saturation has been considered. It is assumed that the jacket inlet temperature can be changed between 95% and 120% of reference temperature, and B concentration in feed can be changed between 0 and 300% of reference concentration.

Table 1: Controller design parameters for I/O linearization approach.

$\beta_{10} = 1$	$\beta_{21} = 5$	$K_{I1} = 312$
$\beta_{11} = 1$	$\beta_{22} = 1$	$K_{C2} = 967$
$\beta_{20} = 6$	$K_{C1} = 481$	$K_{I12} = 413$

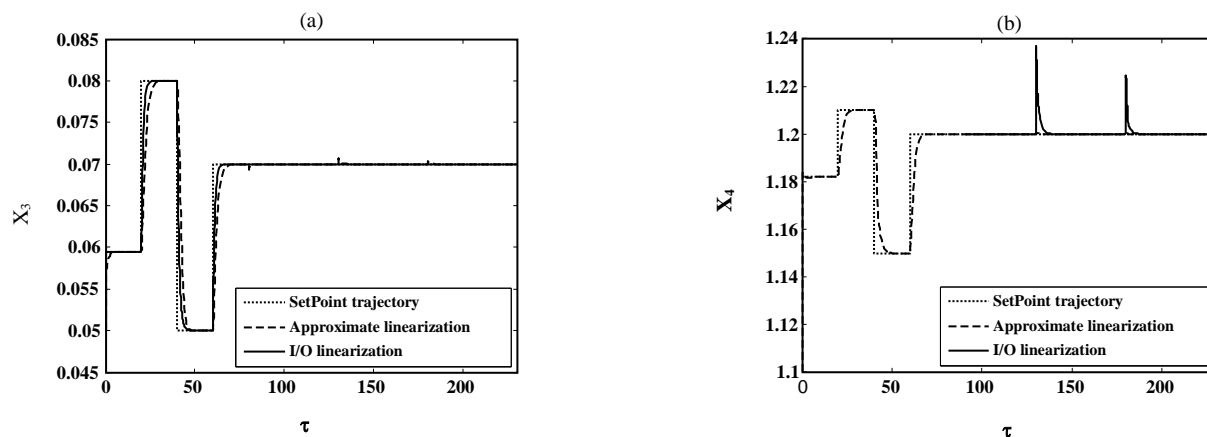
Fig. 2: Set point trajectory and closed loop response of (a)  $x_3$  and (b)  $x_4$ .

For the linearized model, the design weight matrices were chosen as follows:

For the state feedback strategy the weights are chosen as  $R_x = \text{diag}[10 \ 10 \ 50000 \ 5000 \ 10 \ 50000 \ 5000]$ ,  $R_u = I_2$ , where  $I_k$  is a  $k \times k$  identity matrix, and "diag" means diagonal matrix. The genetic algorithm (GA) is applied for tuning the PI controllers for I/O linearization method. For this purpose the MATLAB toolbox for GA is used to minimize the following objective function:

$$\text{objective function} = \int_0^t |x_3 - x_{3,\text{set point}}| dt + \int_0^t |x_4 - x_{4,\text{set point}}| dt$$

Size of the population is chosen to be 100 double vectors which results in faster convergence to the global optimum. The GA converged after 87 generations and consequently the parameters obtained in this generation are used for PI controllers. The crossover and mutation methods are chosen to be scattered and adaptive feasible, respectively. The design parameters of I/O linearization method are given in Table 1.

To illustrate the effectiveness of the proposed controllers, first it is assumed that states are available. The equilibrium point is regarded as the set point. In order to evaluate the performance of the proposed controllers in set point tracking, step changes are applied to set points as shown in Fig. 2.

As can be seen, the desired trajectories are almost better followed by I/O linearization controller. The robustness of the proposed controllers for load rejection is investigated by varying  $\gamma_1$  to 1.1, 1.5, 1.7 at  $\tau = 200, 250, 300$ , respectively. As shown in Fig. 2, the controller based on I/O linearization is not quite as effective in load rejection as the state feedback controller due to its sensitivity with respect to load, however the steady state errors for both controllers are zero. The corresponding control actions are shown in Fig. 3.

In practice, measurement of concentration and generally the whole states simultaneously is difficult and consequently an observer should be used to estimate the states. According to availability of reactor temperature and observability of the system, a Thau observer has been designed based on Eq.(32). The states and feed composition initial conditions for observer were set to:  $[\hat{x}_{10}, \hat{x}_{20}, \hat{x}_{30}, \hat{x}_{40}, \hat{x}_{50}, \hat{\gamma}_{10}]^T = [0.05, 1.9, 0.03, 1, 1, 1.5]^T$ . The observer gain,  $K$ , has been determined using the Riccati equation with the following weights:

$$R_x = \text{diag}[100 \ 100 \ 1000 \ 1000 \ 100 \ 100], R_u = 1.$$

The performances of both schemes including observer dynamics have been tested. As depicted in Fig. 4, the scheme based on I/O linearization operates quite well in set point tracking, but in load rejection the linear state

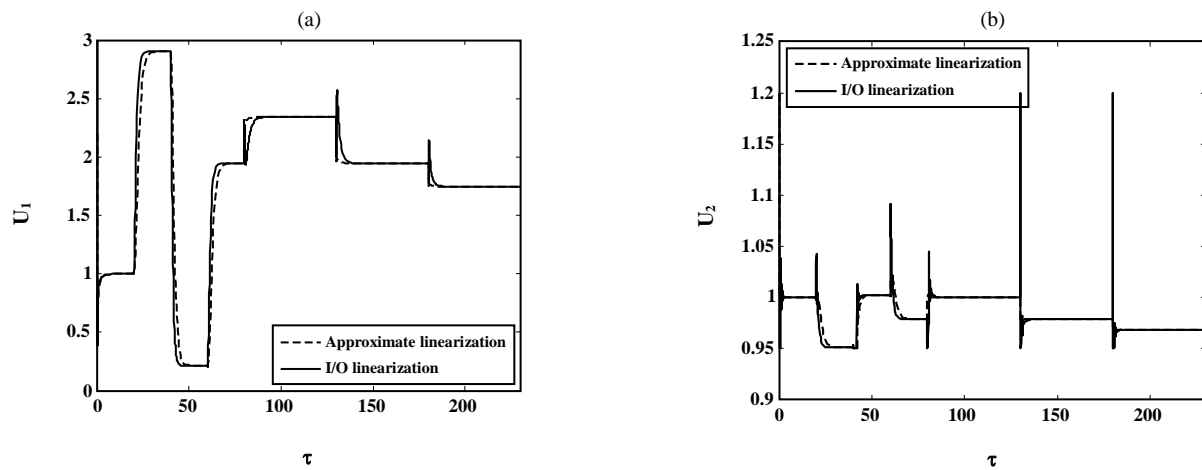

Fig. 3: Control actions (a) dimensionless B concentration in feed (b) dimensionless jacket inlet temperature.

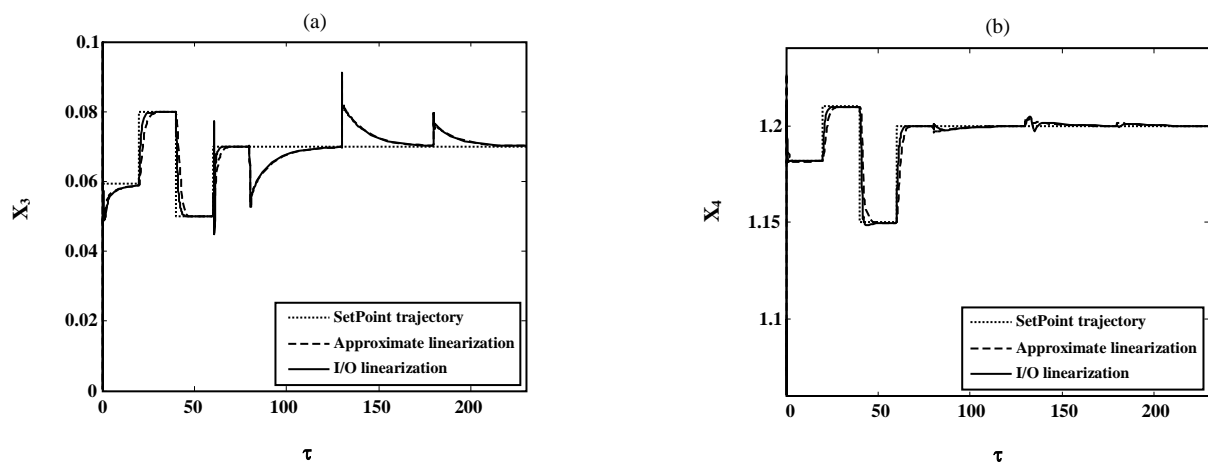

Fig. 4: Set point trajectory and closed loop response using observer (a)  $x_3$  and (b)  $x_4$ .

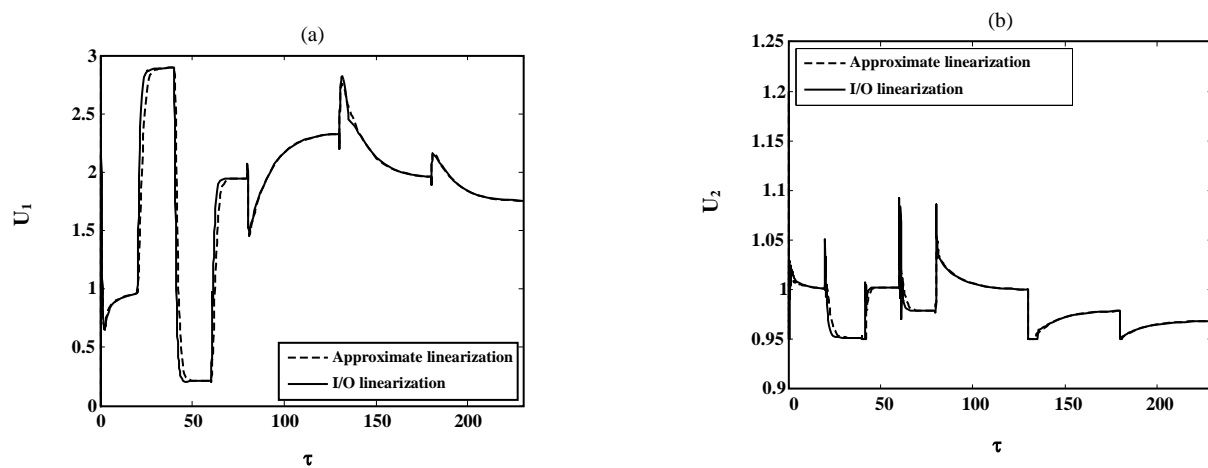

Fig. 5: Control actions (a) dimensionless B concentration in feed (b) dimensionless jacket inlet temperature.

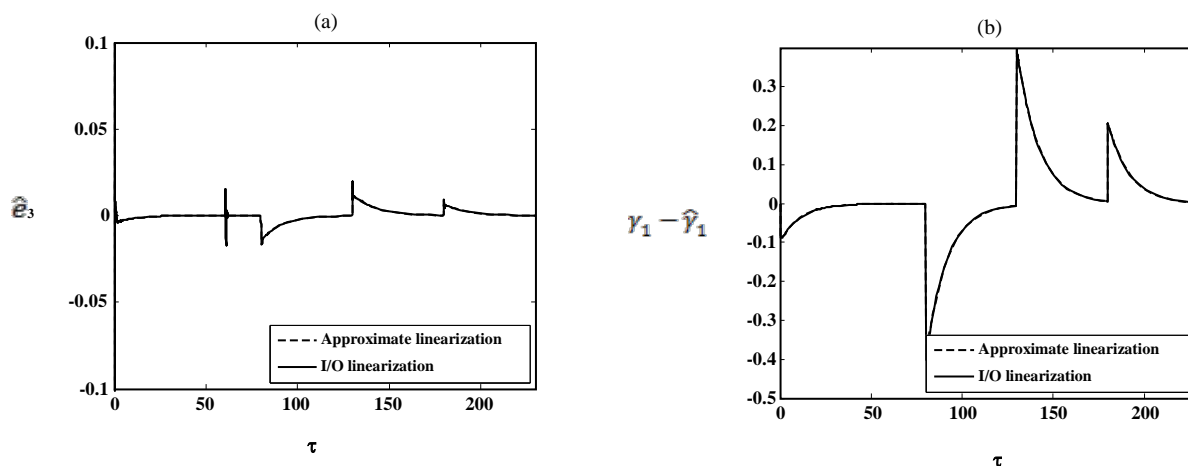

Fig. 6: Estimation error of (a)  $x_3$  (b) feed composition.

feedback has a slightly better performance. The corresponding control actions are shown in Fig. 5. Fig. 6 shows the estimation error of the third state and the estimation error of the feed composition, respectively.

## CONCLUSIONS

In this paper, a non-isothermal CSTR with chaotic behavior was studied. To control the reactor temperature and desired product concentration, two MIMO state feedback controllers were proposed. The first one is the state feedback controller designed based on the linearized model and the second one is designed based on the exact I/O linearization method. Furthermore, a nonlinear full order observer is used to estimate the states. Simulation results indicate that the performances of both schemes are almost the same in set point tracking but the state feedback controller is not sensitive to disturbance while the controller based on I/O linearization is sensitive to load and consequently cannot reject the load as good as the former controller. Therefore it can be concluded that in overall the state feedback controller is more robust in load rejection and has a slightly better performance.

Received : Apr. 20, 2013 ; Accepted : June 10, 2014

## REFERENCES

- [1] Gray P., Scott S.K., [Autocatalytic Reactions in the Isothermal Continuous Stirred Tank Reactor, Oscillations and Instabilities in the System  \$A+2B \rightarrow 3B\$ ;  \$B \rightarrow C\$](#) , *Chemical Engineering Science*, **39**: 1087-1097 (1984).
- [2] Gray P., Scott S.K., [Autocatalytic Reactions in the Isothermal, Continuous Stirred Tank Reactor, Isolates and other Forms of Multistability](#), *Chemical Engineering Science*, **38**: 29-43(1983).
- [3] Peng B., Scott D.K., Showalter K., [Period Doubling and Chaos in a Three Variable Autocatalator](#), *Journal of Physical Chemistry*, **94**: 5243-5246 (1990).
- [4] Lynch D.T., Rogers T.D., Wanke S.E., [Chaos in a Continuous Stirred Tank Reactor](#), *Mathematical Modelling*, **3**: 103-116 (1982).
- [5] Lynch D.T., [Chaotic Behavior of Reaction Systems: Consecutive Quadratic/Cubic Autocatalysis via Intermediates](#), *Chemical Engineering Science*, **48**: 2103-2108 (1993).
- [6] Lynch D.T., [Chaotic Behavior of Reaction Systems: Mixed Cubic and Quadratic Autocatalators](#), *Chemical Engineering Science*, **47**: 4435-4444 (1992).
- [7] Lynch D.T., [Chaotic Behavior of Reaction Systems: Parallel Cubic Autocatalators](#), *Chemical Engineering Science*, **47**: 347-355 (1992).
- [8] Ajbar A., [Stabilization of Chaotic Behavior in a Two Phase Autocatalytic Reactor](#), *Chaos, Solitons & Fractals*, **12**: 903-918 (2001).
- [9] Cordonier G.A., Schmidt L.D., Aris R., [Forced Oscillations of Chemical Reactors with Multiple Steady States](#), *Chemical Engineering Science*, **45**: 1659-1675 (1990).



- [10] Abashar M.E., Elnashaie S.S., [Dynamic and Chaotic Behavior of Periodically Forced Fermentors for Bioethanol Production](#), *Chemical Engineering Science*, **65**: 4894-4905 (2010).
- [11] Perez M., Alberto P., [Self-Oscillating and Chaotic Behaviour of a PI-Controlled CSTR with Control Valve Saturation](#), *Journal of Process Control*, **14**: 51-59 (2004).
- [12] Perez-Polo M., Perez-Monila M., [Saddle-Focus Bifurcation and Chaotic Behavior of a Continuous Stirred Tank Reactor Using PI Control](#), *Chemical Engineering Science*, **74**: 79-92 (2012)
- [13] Elnashaie S.S., Abashar M.E., Teymour F.A., [Bifurcation, Instability and Chaos in Fluidized Bed Catalytic Reactors with Consecutive Exothermic Chemical Reactions](#), *Chaos, Solitons & Fractals*, **3**: 1-33 (1993).
- [14] Teymour F., Ray W.H., [The Dynamic Behavior of Continuous Polymerization Reactors-VI. Complex Dynamics in Full Scale Reactors](#), *Chemical Engineering Science*, **47**: 4133-4140 (1992).
- [15] Ott E. , Grebogi C., Yorke J.A., [Controlling Chaos](#), *Physical Review Letters*, **64**:. 1196-1199 (1990).
- [16] Alasty A., Salarieh H., [Controlling the Chaos Using Fuzzy Estimation of OGY and Pyragas Controllers](#), *Chaos, Solitons & Fractals*, **26**: 379-392 (2005).
- [17] Salarieh H., Shahrokhi M., [Indirect Adaptive Control of Discrete Chaotic Systems](#), *Chaos, Solitons & Fractals*, **34**: 1188-1201 (2006).
- [18] Salarieh H, Alasty A., [Adaptive Control of Chaotic Systems with Stochastic Time Varying Unknown Parametes](#), *Chaos, Solitons & Fractals*, **38**, p. 168-177 (2008)
- [19] Salarieh H., Alasty A., [Stabilizing Unstable Fixed Points of Chaotic Maps via Minimum Entropy Control](#), *Chaos, Solitons & Fractals*, **37**: 763-769, (2008).
- [20] Sadeghian H., Merat K., Salarieh H., Alasty A., [On the Fuzzy Minimum Entropy Control to Stabilize the Unstable Fixed Points of Chaotic Maps](#), *Applied Mathematical Modelling*, **35**: 1016-1023, (2011).
- [21] Rasoulia S., Shahrokhi M., Salarieh H., [Control of a Chemical Reactor with Chaotic Dynamics](#), *Iranian Journal of Chemistry & Chemical Engineering (IJCCE)*, **29**(4): 149-159 (2010).
- [22] Wolf A., Swift J.B., Swinney H.L., Vastano J.A., [Determining Lyapunov Exponents from a Time Series](#), *Physica D*, **16**: 285-317 (1985).
- [23] Kravaris C., Soroush M., [Synthesis of Multivariable Nonlinear Controllers by Input/Output Linearization](#), *AIChE Journal*, **36**: 249-264 (1990).
- [24] Daoutidis P., Kravaris C., [Inversion and Zero Dynamics in Nonlinear Multivariable Control](#), *AIChE Journal*, **37**: 527-538(1991).
- [25] Thau F.E., [Observing the States of Nonlinear Dynamic Systems](#), *International Journal of Control*, **17**: 471-479 (1973).