

Mononuclear and Dinuclear Copper(II) Complexes Containing N, O and S Donor Ligands: Synthesis, Characterization, Crystal Structure Determination and Antimicrobial Activity of $[\text{Cu}(\text{phen})(\text{tda})].2\text{H}_2\text{O}$ and $[(\text{phen})_2\text{Cu}(\mu\text{-tda})\text{Cu}(\text{phen})](\text{ClO}_4)_2.1.5\text{H}_2\text{O}$

Abbaszadeh, Abolfazl; Safari, Nasser⁺; Amani, Vahid; Notash, Behrouz*
Department of Chemistry, Shahid Beheshti University, P.O. Box 1983963113 Tehran, I.R. IRAN

Raei, Fereshteh; Eftekhari, Fereshteh
Department of Microbiology, Faculty of Biological Sciences, Shahid Beheshti University,
P.O. Box 1983963113 Tehran, I.R. IRAN

ABSTRACT: Copper complexes of $[\text{Cu}(\text{phen})(\text{tda})].2\text{H}_2\text{O}$ (**1**) and $[(\text{phen})_2\text{Cu}(\mu\text{-tda})\text{Cu}(\text{phen})](\text{ClO}_4)_2.1.5\text{H}_2\text{O}$ (**2**) (where phen is 1,10-phenanthroline and tda^{2-} is thiodiacetate) have been synthesized. Both complexes were characterized by elemental analysis, IR, UV-Vis spectroscopy and cyclic voltammetry. Their solid state structures were determined by the single crystal X-Ray Diffraction method. Complex **1** is mononuclear and copper has accepted a five-coordinated square-based pyramidal structure with the tda^{2-} anion facially coordinated to copper(II). Complex **2** has accepted an unsymmetrical square pyramidal coordination of two distinct copper complexes, one containing two phenanthroline and the other containing one phenanthroline and one tda^{2-} , bridged by a carboxylate oxygen. The strong biological activity of these compounds against six reference bacterial included *Bacillus subtilis* (ATCC 465), *Enterococcus faecalis* (ATCC 29737), *Staphylococcus aureus* (ATCC 25923), *Escherichia coli* (ATCC 25922), *Klebsiella pneumoniae* (ATCC 10031), and *Pseudomonas aeruginosa* (ATCC 85327) were investigated.

KEY WORDS: Cu(II) complexes, 1,10-Phenanthroline, Thiodiacetic acid, Crystal structure, Cyclic voltammogram. Antimicrobial activities.

INTRODUCTION

In recent years, transition metal complexes have received attention owing to their particular structures and immense applications in catalysis, adsorption, electric conducting materials and magnetic and optical materials [1–8].

Copper is a significant transition metal in biology and coordination chemistry [9,10]. Mono and multinuclear copper complexes have frequently been observed in a wide range of enzymes [8,9], therefore much consideration

* To whom correspondence should be addressed.

+ E-mail: n-safari@sbu.ac.ir

1021-9986/14/4/1

13/\$/3.30

has been focused in recent years to the characterization of dinuclear and polynuclear transition metal complexes bridged by special S, N, O containing ligands. The complexes are interesting not only as potential patterns of biological systems [13,14] but also from a material science point of view. Such magnetochemical material show that considerable notice has been focused on the utilization of copper complexes of 1,10-phenanthroline and its derivatives in biological activities such as antitumor, anti-candida, antimycobacterial, antimicrobial activity, etc. [15-21]. Furthermore 2,2'-thiodiacetic acid (H_2tda) and its derivative metal complexes have attracted attention due to their particular coordination symmetry and stereochemistry. The coordination mode of this ligand still needs to be explored. Tda^{2-} can possibly be a monodentate, bidentate and tridentate ligand; it can also be a bridging or chelating ligand, thus tda^{2-} can display a variety of coordination modes [22].

Contrary to the biological relation of the sulfur atom in thioether, we reports on the coordinating properties of ligands comprising this donor atom have become visible hence, we decided to develop our structural researchs to mixed ligand copper(II) complexes containing N_2O_2S [23-31]. Herein we synthesized mononuclear and dinuclear compounds with 2,2'-thiodiacetic acid and phenanthroline because, in this reactions control of pH seems essential for the self-assembling of the monomer to oligomer or maybe polymer.

Taking advantage of the ability of both 2,2'-thiodiacetic acid ligand by N, S, O moiety and 1,10-phenanthroline moiety, we have synthesized and characterized two new Cu(II) complexes. One complex is mononuclear, although mononuclear of copper(II) comprising carboxylate are fully limited [32]. The other complex is self-assembled to form a dinuclear with two pairs of distinct copper(II) ions in its structure. Mononuclear and dinuclear complexes have 1,10-phenanthroline and 2,2'-thiodiacetic ligand and their topologies were contorted by the presence of triethylamine and ethylene diamine bases, respectively. In fact, we have investigated similar structures [22,33] and our goal was to make these structures sensitive to pH changes and to convert them from the mononuclear form to dinuclear form, or, conversely, from the dinuclear form to mononuclear form. Furthermore, we have investigated the antibacterial activity of these compounds.

EXPERIMENTAL SECTION

Materials and instruments

All chemicals were purchased from Merck and Aldrich. Six reference bacterial strains were used which included *Bacillus subtilis* (ATCC 465), *Enterococcus faecalis* (ATCC 29737), *Staphylococcus aureus* (ATCC 25923), *Escherichia coli* (ATCC 25922), *Klebsiella pneumoniae* (ATCC 10031), and *Pseudomonas aeruginosa* (ATCC 85327). Infrared spectra ($4000-250\text{ cm}^{-1}$) of solid samples were taken as 1% dispersions in CsI pellets using a Shimadzu-470 spectrometer. UV-Vis spectra were recorded on a Shimadzu 2100 spectrometer using a 1cm path length cell. Melting points were obtained by a Kofler Heizbak Rechart type 7841 melting point apparatus. Cyclic Voltammetry (CV) measurements were carried out on a μ -Autolab III electrochemical workstation with H_2O solution containing 0.1M supporting electrolyte of KCl in a three-electrode cell, where Glassy Carbon, Pt wire and Ag/Ag^+ were used as the working electrode, the counter electrode, and the reference electrode, respectively.

Synthesis of $[Cu(phen)(tda)]_2 \cdot 2H_2O$ (1)

2,2'-Thiodiacetic acid (0.04 g, 0.29 mmol) was dissolved in a mixture of 3 mL methanol, 3 mL water and 2.5 mL Et_3N (0.30 M in methanol solution, 0.67 mmol). Then $CuCl_2 \cdot 2H_2O$ (0.05 g, 0.29 mmol) was added to the solution and the reaction mixture was stirred. 1,10-Phenanthroline (0.06 g, 0.29 mmol) was added to the stirred solution. The resulting light blue solution was stirred at $40-45\text{ }^\circ\text{C}$ for 25 min and pH of the solution became 8. This solution was left to evaporate slowly at room temperature. After 10 days, blue crystals of **1** were isolated (yield 76.5%, m.p. $190-192\text{ }^\circ\text{C}$). Selected IR frequencies (cm^{-1}) are reported in Table 1. UV-Vis, λ_{max} : 275 nm. Anal. Calcd. C, 44.91; H, 3.74; N, 6.54. Found: C, 44.52; H, 3.72; N, 6.50%.

Synthesis of $[(phen)_2Cu(\mu\text{-tda})Cu(phen)](ClO_4)_2 \cdot 1.5H_2O$ (2)

2,2'-Thiodiacetic acid (0.04 g, 0.29 mmol) was dissolved in a mixture of 3 mL methanol, 3 mL water and 2 mL ethylene diamine (0.30 M in methanol solution, 0.58 mmol). Then $CuCl_2 \cdot 2H_2O$ (0.05 g, 0.29 mmol) was added to the solution and the reaction mixture was stirred. 1,10-Phenanthroline (0.06 g, 0.29 mmol) and after a few minutes

Table 1: Selected IR frequencies (cm^{-1}) for complexes **1**, **2** and ligands.

	H ₂ tda	Phen	Complex 1	Complex 2
$\nu(\text{C-H})_{\text{cycle}}$	-	3032	3060br	3069br
$\nu(\text{C=C})$	-	1587	1582s	1577s
$\nu(\text{C=N})$	-	1447	1345m	1338m
$\nu(\text{C-N})$	-	1142	926m	-
$\nu(\text{Cu-N})$	-	-	450w	439w
$\nu(\text{Cu-S})$	-	-	284w	256w
$\nu(\text{Cu-O})$	-	-	319w	313w,374w
$\nu(\text{C-S})$	867	-	857m	851m
$\nu_{\text{as}}(\text{COO})$	1697		1617vs	1634vs
$\nu_{\text{s}}(\text{COO})$	1429		1402, 1425m	1391,1422m
$\nu(\text{O-H})$	3063br		3440br	3430br

KClO₄ (0.04g , 0.29 mmol) were added to the stirred solution. The resulting violet solution stirred at 40 – 45 °C for 25 min. This solution was left to evaporate slowly at room temperature. After two weeks; green crystals of **2** were isolated (yield 67.4%, m.p. 198-200 °C). Selected IR frequencies (cm^{-1}) are reported in Table 1. UV-Vis, λ_{max} : 273 nm. Anal. Calcd. C, 46.11; H, 2.98; N, 8.06. Found: C, 45.64; H, 2.96; N, 8.02%.

Crystal structure determination and refinement

The X-ray diffraction measurements were made on a STOE IPDS-II diffractometer with graphite monochromated Mo-K α radiation. For **1**, a blue needle crystal of 0.30 × 0.10 × 0.05 mm and for **2**, a blue plate crystal of 0.45 × 0.35 × 0.15 mm were mounted on a glass fiber and used for data collection. Cell constants and an orientation matrix for data collection were obtained by least-squares refinement of the diffraction data from 6370 for **1** and 23117 for **2** unique reflections. Data were collected at 298(2) and 120(2) K to a maximum 2 θ value of 58.34° for **1** and 58.32° for **2** and in a series of ω scans in 1° oscillations and integrated using the Stoe X-AREA [34] software package. The numerical absorption coefficient, μ , for Mo-K α radiation is 1.647 mm⁻¹ for **1** and 1.535 mm⁻¹ for **2**. A numerical absorption correction was applied using X-RED [35] and X-SHAPE [36] software. The data were corrected for Lorentz and Polarizing effects. The structures were solved by direct methods and subsequent differences Fourier map, and

then refined on F^2 by a full-matrix least-squares procedure using anisotropic displacement parameters [37]. All hydrogen atoms except for water molecules, for **1** and **2** were added at ideal positions and constrained to ride on their parent atoms with $U_{\text{iso}}(\text{H}) = 1.2U_{\text{eq}}$. Atomic factors are from the International Tables for X-ray Crystallography [38]. All refinements were performed using the X-STEP32 crystallographic software package [39]. A summary of the crystal data, experimental details and refinement results is given in Table 2.

RESULTS AND DISCUSSION

Synthesis of compounds **1** and **2**

2,2'-Thiodiacetic acid (H₂tda) also expressed by thiodiglycollic acid and bis(carboxymethyl)sulfide is a dicarboxylic acid. It exists as an equilibrium mixture of H₂tda, Htda⁻ and tda²⁻ in an aqueous solution. The complexation reactivity of this ligand relates to its degree of deprotonation, i.e. the pH of the solution. When pH of the reaction mixture was cautiously controlled by the addition of Et₃N to the mixture of CuCl₂·2H₂O H₂tda and phenanthroline, complex **1** was obtained in methanol-water (pH = 8) in this condition 2,2'-thiodiacetic acid is in the form of the tda²⁻ acts as a tridentate ligand. On the other hand, complex **2** is a dinuclear copper that was simultaneously prepared from the reaction of CuCl₂·2H₂O with H₂tda-phen mixture in the presence of KClO₄ and ethylene diamine in methanol-water (pH = 5). Yields of 76.5% for **1** and 67.4% for **2** were obtained (Scheme 1).

Table 2: Crystallographic and structural refinement data for complexes 1 and 2.

Complex	1	2
Formula	C ₁₆ H ₁₆ CuN ₂ O ₆ S	C ₈₀ H ₆₂ Cl ₄ Cu ₄ N ₁₂ O ₂₇ S ₂
Formula weight	427.91	2083.51
T (K)	298(2)	120(2)
λ (Å)	0.71073	0.71073
Crystal system	Orthorhombic	Triclinic
Space group	Ama2	Pt
Crystal size (mm ³)	0.3 × 0.1 × 0.05	0.45 × 0.35 × 0.15
a (Å)	18.280(4)	12.113(2)
b (Å)	19.858(4)	12.487(3)
c (Å)	4.7876(10)	13.726(3)
α (°)	90.00	94.70(3)
β (°)	90.00	100.41(3)
γ (°)	90.00	103.15(3)
V (Å ³)	1737.9(6)	1971.9(8)
Z	4	1
D _{calc} (g/cm ³)	1.635	1.750
F(000)	876	1058
Absorption coefficient (mm ⁻¹)	1.413	1.347
Index range	-24 ≤ h ≤ 25 -26 ≤ k ≤ 26 -5 ≤ l ≤ 6	-16 ≤ h ≤ 16 -17 ≤ k ≤ 16 -18 ≤ l ≤ 18
Data collected	6370	23117
Unique data [R(int)]	2288, (0.0674)	10583, (0.0578)
Parameters, restraints	130,2	593,0
Final R ₁ , wR ₂ ^a (observed data)	0.0395, 0.0866	0.0546, 0.1040
Final R ₁ , wR ₂ ^a (all data)	0.0482, 0.0907	0.0903, 0.1138
Goodness-of-fit on F ²	1.069	1.012
Largest difference in peak and hole (e Å ⁻³)	0.330, -0.346	1.222, -0.671
Unique data [R(int)]	2288, (0.0674)	10583, (0.0578)

$$^a R_1 = \frac{\sum ||F_o| - |F_c||}{\sum |F_o|}, wR_2 = \frac{[\sum (w(F_o^2 - F_c^2)^2)]^{1/2}}{\sum w(F_o^2)^2}^{1/2}$$

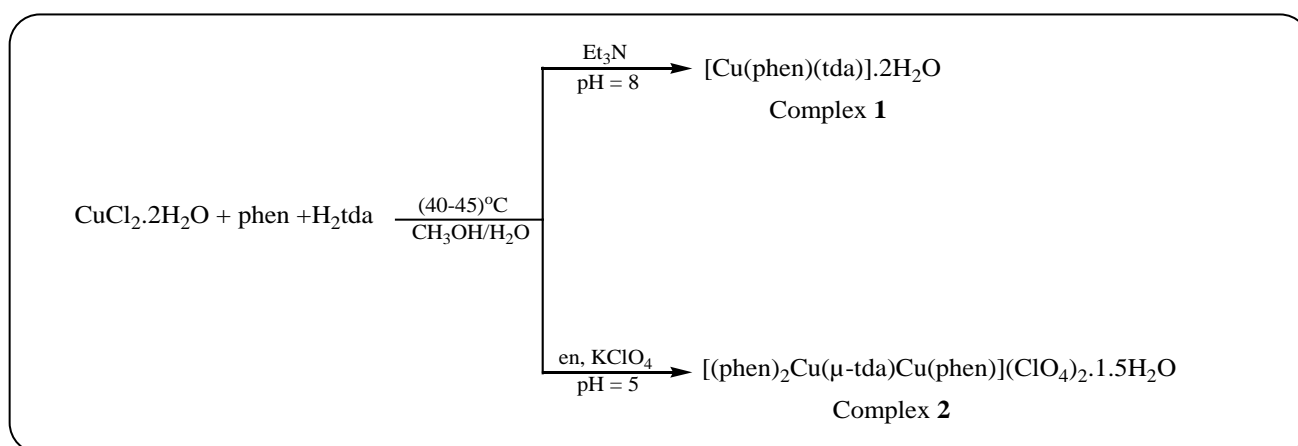

Scheme 1: The preparation method of 1 and 2.

It seems that the control of pH in these reactions is significant for the self-assembling of the obtained monomer to oligomer or maybe polymer.

Spectroscopic characterization of **1** and **2**

Infrared spectra in Table 1 displays the vibration frequencies for free and coordinated tda^{2-} and phen ligands in compounds **1** and **2**. Resembling shifts have been observed for tda^{2-} ligands coordinated to other metals as well [22,33] and can be described by changing the geometry of the free ligand of the tda^{2-} from *anti* to *syn* configuration and also by electron increase in the complex by phen donor ligand as well as COOH groups deprotonation. The IR spectra of **1** and **2** are mainly distinguished from tda^{2-} by metal to ligand stretches. The bands at 284 and 256 cm^{-1} were assigned to $\nu(\text{Cu-S})$ frequencies for **1** and **2**, respectively. In addition, the bands at 450 and 439 cm^{-1} were assigned to $\nu(\text{Cu-N}_{\text{phen}})$ in complex **1** and **2** [40] and the bands at 319 and (313, 374) cm^{-1} were assigned to $\nu(\text{Cu-O})$ in complex **1** and **2**. IR spectra of **1** and **2** distinguish the coordination modes of 2,2'-thiodiacetic acid molecules; Table 1. Complex **1** showed a very strong band at 1617 cm^{-1} which is related to the ν_{as} of COO^- group [22]. Similarly, this band is at 1634 cm^{-1} for complex **2** [33, 41], indicating the coordination of one COO^- group to two COO^- groups in **2**. It also shows two different $\nu(\text{Cu-O})$ frequencies for complex **2** compared to **1**. Moreover, each complex displayed an antisymmetric and symmetric (COO^-) group. The strong bands corresponding to $\nu_{\text{s}}(\text{COO})$ appeared at 1402-1365 cm^{-1} for complex **1** and 1422-1391 cm^{-1} for complex **2**. The “ Δ criterion” which is based on the variation in the $\nu_{\text{as}}(\text{COO}^-)$ and $\nu_{\text{s}}(\text{COO}^-)$ amount of isophthalic acid carboxylate group, was employed to define the coordinating mode of the carboxylate group [42-43]. The $\Delta\nu$ are 215 cm^{-1} and 252 cm^{-1} for complex **1**. These $\Delta\nu$ amounts are comparable to those of iminodiacetic acid (chelating) complexes [43]. On the other hand, the $\Delta\nu$ amounts for complex **2** are 212 cm^{-1} and 243 cm^{-1} . In addition, the infrared spectrum of H_2tda shows a very broad band in the range 3073-3063 cm^{-1} , which is allocate to $\nu(\text{O-H})$ in the COOH group. In complex formation with copper(II) this band disappears, indicating the deprotonation of the acid followed by its coordination through carboxylate oxygen atoms. This is further verified by the shifts [39] in the $\nu_{\text{as}}(\text{COO}^-)$

(1697 cm^{-1}) and $\nu_{\text{s}}(\text{COO}^-)$ (1429 cm^{-1}) bands of H_2tda , respectively, to 1634-1617 and 1422-1402 cm^{-1} in the complexes. In addition, the variation between these two bands $\Delta\nu$ [$\nu_{\text{as}}(\text{COO}^-)-\nu_{\text{s}}(\text{COO}^-)$] is specific to the unidentate mode of coordination of carboxylate to copper(II) in all of the complexes, which is verified by the X-ray crystal structures of the complexes. A strong band range of 3440 and 3528 cm^{-1} observed for **1** and **2**, respectively, is adaptive to $\nu(\text{O-H})$ of non-coordinated water.

The UV-Vis spectra of the DMSO solutions of **1** and **2** have bands at 275 and 273 nm, respectively, which can be assigned to $\pi \rightarrow \pi^*$ transitions.

Cyclic voltammetric data for Cu(II) complexes of **1** and **2** in H_2O at a scan rate of 100 mV/s

The cyclic voltammograms of the complexes have been recorded in the potential range from -0.55 to 0.82 V at a scan rate of 100 mV/s. The electrochemical properties of the complexes were investigated in H_2O containing 0.1 M KCl as a supporting electrolyte. Complex **1** shows a quasi reversible anodic peak at 0.12 V and the corresponding cathodic peak at -0.11 V (Fig. 1) can be expressed as $\text{Cu(II)} \leftrightarrow \text{Cu(I)}$. The redox processes of the two metal centers of complex **2** shows two quasi reversible anodic peaks at 0.138 V for Cu(I) containing two phen and 0.38 V for Cu(I) containing one phen in the complex structure that can be expressed as:

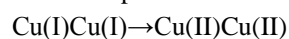

and the corresponding two distinct cathodic peaks at -0.073 V for Cu(II) containing one phen and -0.32 V for Cu(II) containing two phen in the complex structure that can be expressed as $\text{Cu(II)Cu(II)} \rightarrow \text{Cu(I)Cu(I)}$ [44] (Fig. 1, Table 3).

Description of the molecular structures of **1** and **2**

Crystallographic data for **1** and **2** are given in Table 2 and selected bond lengths and angles are presented in Table 4 and Table 5. The crystal structure of **1** is given in Fig. 2. The asymmetric unit of **1** contains one Cu(II) atom, one half of phen, one half of tda^{2-} and one non coordinated water molecule. The copper atom is coordinated by two oxygen atoms (O1, O1a) and the tertiary sulfur (S1) atoms of the *cis*-facially are coordinated to the tda^{2-} anion and two phen nitrogen atoms (N1, N1a) in *fac*-O2+ S(apical) conformation mode (Scheme 2a) [22]. The value of the structural index [45,46]

Table 3: Electrochemical data for the copper(II) complexes at 25.0 ± 0.2°C.

Compound	E _{1pa} (V)	E _{1pc} (V)	E _{1/2} (V)	ΔE ₁ (V)	E _{2pa} (V)	E _{2pc} (V)	E _{2/2} (V)	ΔE ₂ (V)
1	0.12	-0.11	0.005	0.23	-	-	-	-
2	0.138	-0.073	0.032	0.211	0.38	-0.32	0.03	0.7

Table 4: Bond distances (Å) and bond angles (°) for 1.

Bond lengths (Å)			
Cu1-O1	1.938(2)	Cu1-N1	2.006(3)
Cu1-N1#1	2.006(3)	Cu1-S1	2.5880(12)
Bond angles (°)			
O1-Cu1-O1#1	92.81(16)	N1#1-Cu1-N1	82.01(16)
O1-Cu1-N1#1	164.44(10)	O1-Cu1-S1	83.10(7)
O1#1-Cu1-N1#1	90.75(11)	O1#1-Cu1-S1	83.10(7)
O1-Cu1-N1	90.75(11)	N1#1-Cu1-S1	112.38(8)
O1#1-Cu1-N1	164.44(10)	N1-Cu1-S1	112.38(8)

Symmetry code: (#1) -x+1/2,y,z

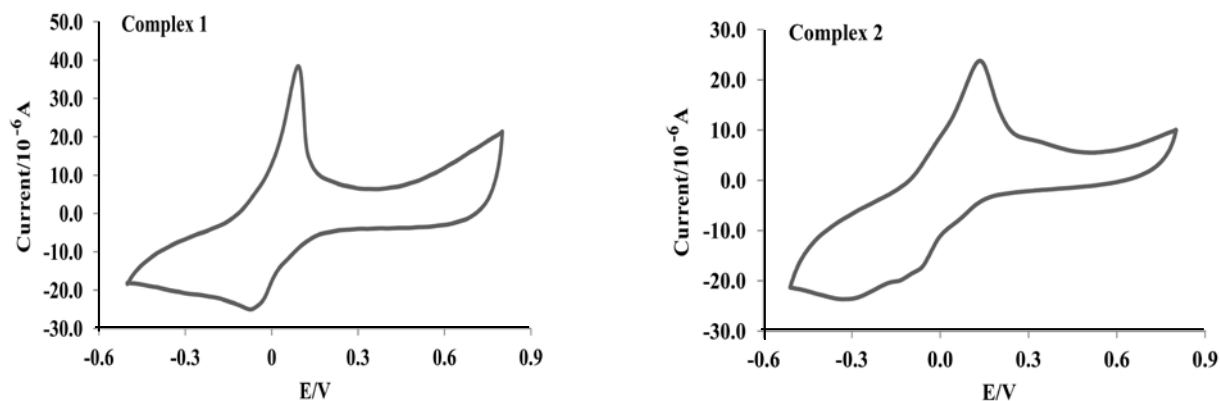
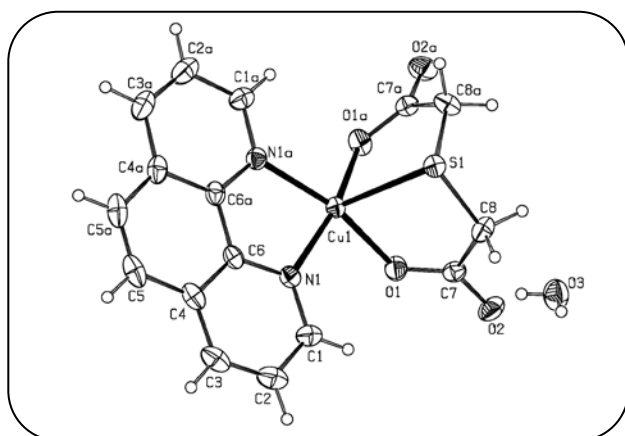
**Fig. 1: Cyclic voltammogram of complexes 1 and 2 in H₂O at a scan rate of 100 mV/s.****Fig. 2: The molecular structure of [Cu(phen)(tda)].2H₂O (1), with the atom-numbering scheme and 30% probability displacement ellipsoids; symmetry code: (a) 1/2-x,y,z.**

τ of 0.0 [$\tau = (\beta - \alpha)/60$, where $\alpha = \text{N1-Cu1-O1a} = 164.4^\circ$ and $\beta = \text{O1-Cu1-N1a} = 164.4^\circ$; for the entire square pyramidal and trigonal bipyramidal geometries the τ amounts are zero and unity, respectively] discloses that the coordination geometry in the vicinity of copper(II) is a square pyramid SP with the corners of the CuN₂O₂ square plane occupied by N1, N1a and O1, O1a atoms where the two O(carboxyl) tda-donors fall in *trans* to the N(phen)donors in a regular square basis. The apical situation is occupied by S1 sulfur atom at a distance of 2.588 Å, longer than the equatorial O, N atoms (Cu-O1, 1.938 Å) and (Cu1-N1, 2.006 Å) as a conclusion of the presence of two electrons in dz² orbital and a soft (S thioether) donor atom to hard (O carboxyl) and (N phen) donors atoms. Interestingly, the Cu1-N1 and Cu1-N1

Table 5: Bond distances (Å) and bond angles (°) for **2**.

Bond lengths (Å)			
Cu1-O4	1.982(2)	Cu2-O1	1.926(3)
Cu1-N1	1.989(3)	Cu2-N5	2.006(3)
Cu1-N3	1.992(3)	Cu2-N6	2.006(3)
Cu1-N4	2.052(3)	Cu2-O3	2.197(2)
Cu1-N2	2.188(3)	Cu2-S1	2.3664(10)
Bond angles (°)			
O4-Cu1-N1	91.18(11)	N4-Cu1-N2	88.78(10)
O4-Cu1-N3	92.25(11)	O1-Cu2-N5	91.35(11)
N1-Cu1-N3	175.94(11)	O1-Cu2-N6	162.62(11)
O4-Cu1-N4	161.70(10)	N5-Cu2-N6	82.33(12)
N1-Cu1-N4	94.09(11)	O1-Cu2-O3	96.29(11)
N3-Cu1-N4	81.98(12)	N5-Cu2-O3	99.50(10)
O4-Cu1-N2	109.36(10)	N6-Cu2-O3	100.71(10)
N1-Cu1-N2	80.87(11)	O1-Cu2-S1	86.38(8)
N3-Cu1-N2	99.99(11)	N5-Cu2-S1	176.89(8)

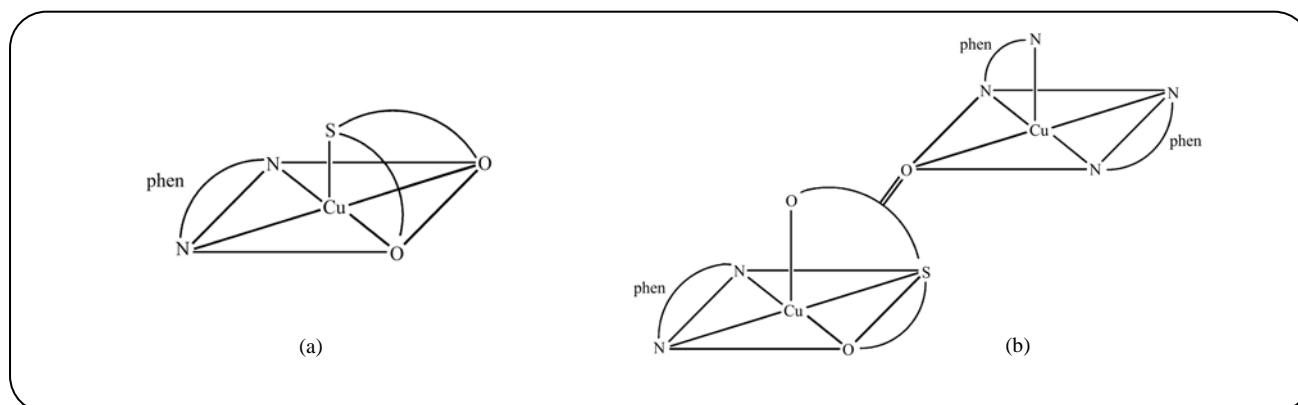

Scheme 2: Types of metal-tda binding roles in copper(II) complexes (a): *fac-O2 + S(apical)* conformation mode (b): *fac-SO + O(apical) + μ-η₁:η₁* bridging mode.

a bond and the Cu1-O1 and Cu1-O1a have the same bond length (2.006 and 1.938 Å, respectively) because of the same symmetry and environment. The equatorial positioning the COO⁻ groups in this complex are the shortest (1.938 Å) and therefore the strongest bonds formed by the COO⁻ and N phen, defining the equatorial xy-plane, rather than one of them defaulting to a weaker bound z-axial position in complex **1**. So, the sulfur atom of tda²⁻ anion in this complex occupies the axial position because of the powerful chelation of the carboxylate

oxygen and phen nitrogen atoms in the equatorial plane. The Cu-N, Cu-O and Cu-S bond lengths and angles in complex **1** are in good agreement with the corresponding values in [Cu(tda)(5Me-phen)].2H₂O [22] and [Cu(tda)(bipy)(H₂O)] [47] (5Me-phen is 5-methyl-1,10-phenanthroline and bipy is 2,2'-bipyridine). The distortion of copper(II) circumambient arises not only from the longest Cu-S(thioether) bond (2.588 Å) but also from the strength in the metal(II) chelate rings, the mean planes of both chelate rings sharing the Cu-S bond describe

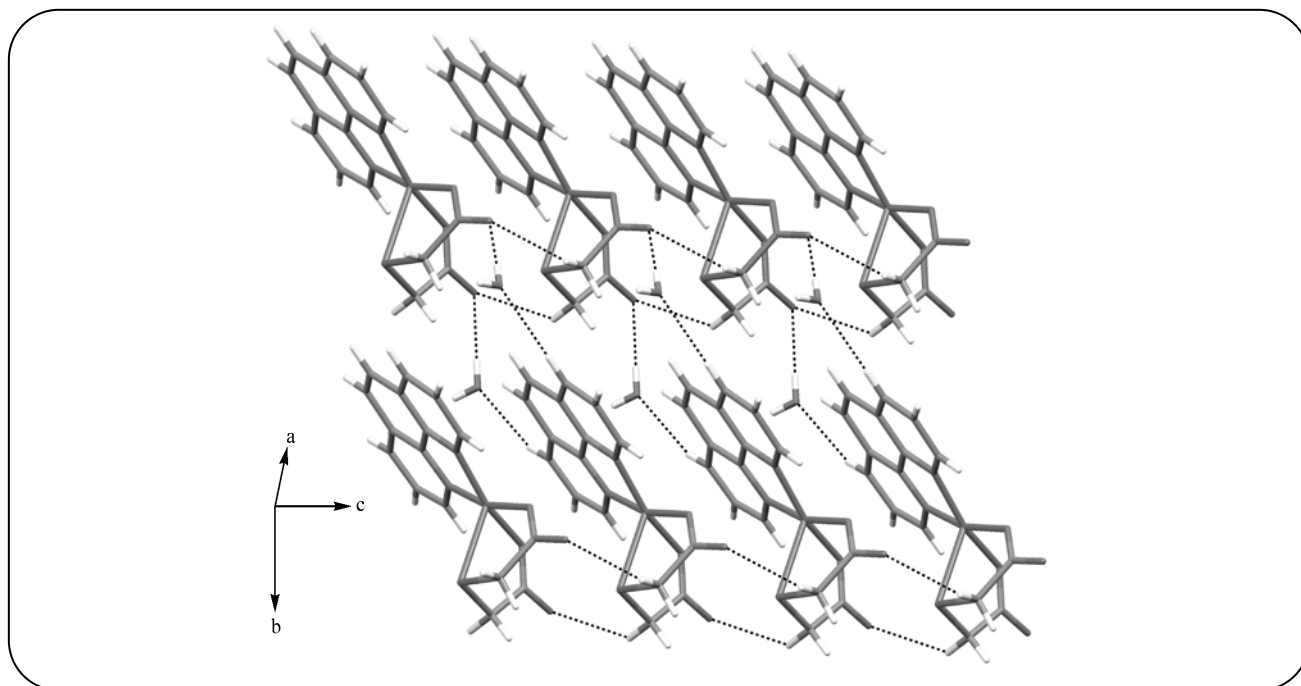

Fig. 3: Crystal packing diagram for $[\text{Cu}(\text{phen})(\text{tda})].2\text{H}_2\text{O}$ (**1**). Intermolecular interactions are shown as dashed lines.

a dihedral angle of 83.1° . The Cu-S bond deviates 19.3° from the perpendicular to the mean basic plane.

In the crystal structures of **1**, Fig. 3, there is no $\pi \dots \pi$ interaction between the pyridine and phenyl rings, and only intermolecular C-H...O hydrogen bonds (Table S1) are effective in the stabilization of the crystal structure and formation of the 2-D supramolecular assembly.

The molecular structure of **2** is displayed in Fig. 4. The structure of **2** consists of two five-coordinated Cu(II) atoms bridged by 2,2'-thiodiacetate, one and half uncoordinated water molecules and also two uncoordinated perchlorate anions. Complex **2** is the dinuclear of complex **1**; in this compound tda^{2-} bridges between two copper atoms and the Cu1 atom is coordinated by two phen and one oxygen of tda^{2-} (O4) whereas the Cu2 atom is coordinated by two oxygen (O1, O3) and the tertiary sulfur (S1) atoms of the cis-facially coordinated tda^{2-} anion and two phen nitrogen atoms (N5, N6) in $\text{fac-SO}+\text{O}(\text{apical})+\mu-\eta_1:\eta_1$ bridging mode (Scheme 2b) [22]. Both the stereochemistry around the copper atoms is various. We have utilized the angular structural parameter $\tau = (\beta - \alpha)/60$, as a usual descriptor of five-coordinated copper centers, for the designation of the coordination geometry ($\tau = 1$ for an ideal trigonal bipyramid and $\tau = 0$ for an ideal square-based pyramid)

[45, 46]. Afterwards, as indicated by X-ray analysis, the coordination geometry environment of the Cu(2) atom in **2** can be depicted as a nearly ideal tetragonal pyramid $\tau = 0.237$ where $\alpha = \text{O1-Cu2-N6} = 162.62^\circ$ and $\beta = \text{S1-Cu2-N5} = 176.89^\circ$; $\tau = 0.237$, whereas the donor-atom arrangement environment of the Cu(1) atom is considerably disfigured with $\tau = 0.236$ where $\alpha = \text{N4-Cu1-O4} = 161.7^\circ$ and $\beta = \text{N1-Cu1-N3} = 175.9^\circ$ and it displays a trigonal bipyramid distorted square-based pyramidal TBDSBP [46] with the corners of the CuN_3O and CuN_2OS square plane being occupied by N1, N3 and N4 nitrogen atoms of phen and O4 oxygen atom of tda^{2-} for Cu1 also by N5 and N6 nitrogen atoms of phen and O1 oxygen, S1 sulfur atoms of tda^{2-} for Cu2, respectively. The apical position is occupied by O3 oxygen atom (Cu2-O3, 2.197 Å) at a distance longer than the equatorial O1 atom (Cu2-O1, 1.927 Å) as a consequence of the presence of two electrons in d_{z^2} orbital and also the apical situation is occupied by the N2 nitrogen atom (Cu1-N2, 2.188 Å) at a distance longer than the equatorial N1 atom (Cu1-N1, 1.989 Å) as a conclusion of the presence of two electrons in d_{z^2} orbital and the Cu1-N3_{phen} bond (1.992 Å) is shorter than the other Cu1-N4_{phen} bond (2.052 Å), as it is *trans* to the weaker Cu1-N1_{phen} bond and the stronger Cu1-O4 bond. The O4 and O3 atoms of the carboxylate

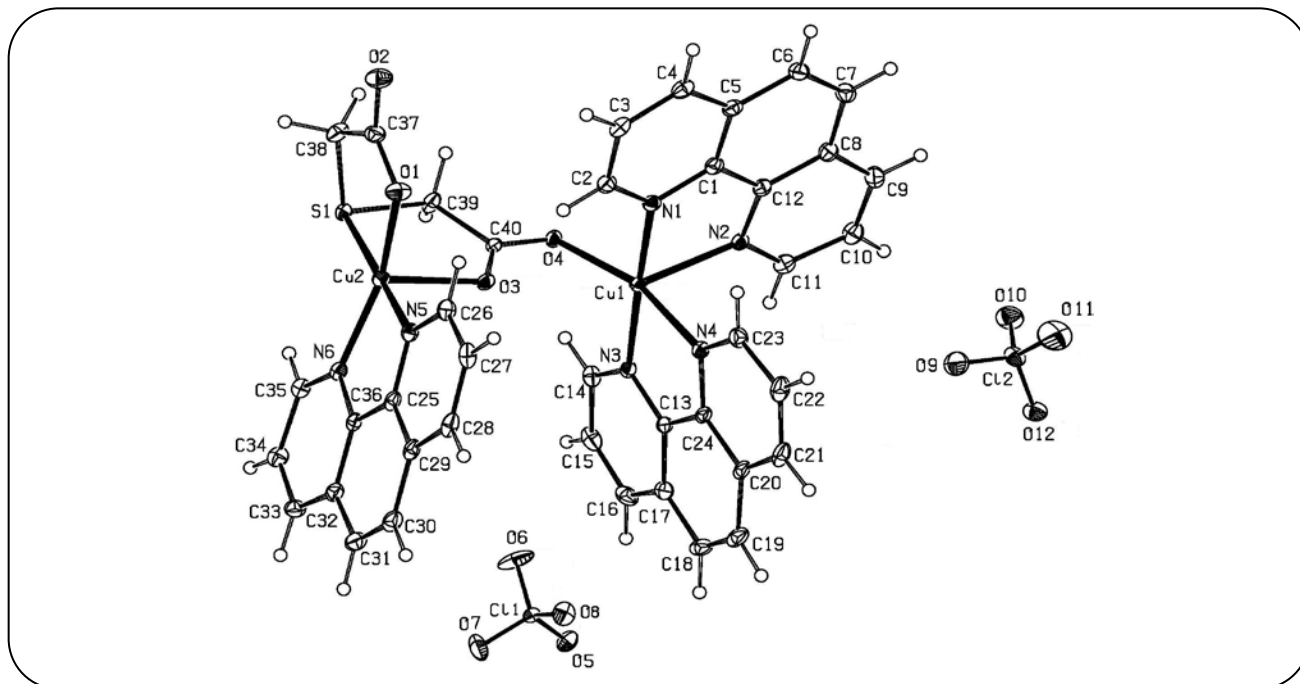

Fig. 4: The molecular structure of $[(\text{phen})_2\text{Cu}(\mu\text{-tda})\text{Cu}(\text{phen})](\text{ClO}_4)_2 \cdot 1.5\text{H}_2\text{O}$ (**2**), with the atom-numbering scheme and 30% probability displacement ellipsoids.

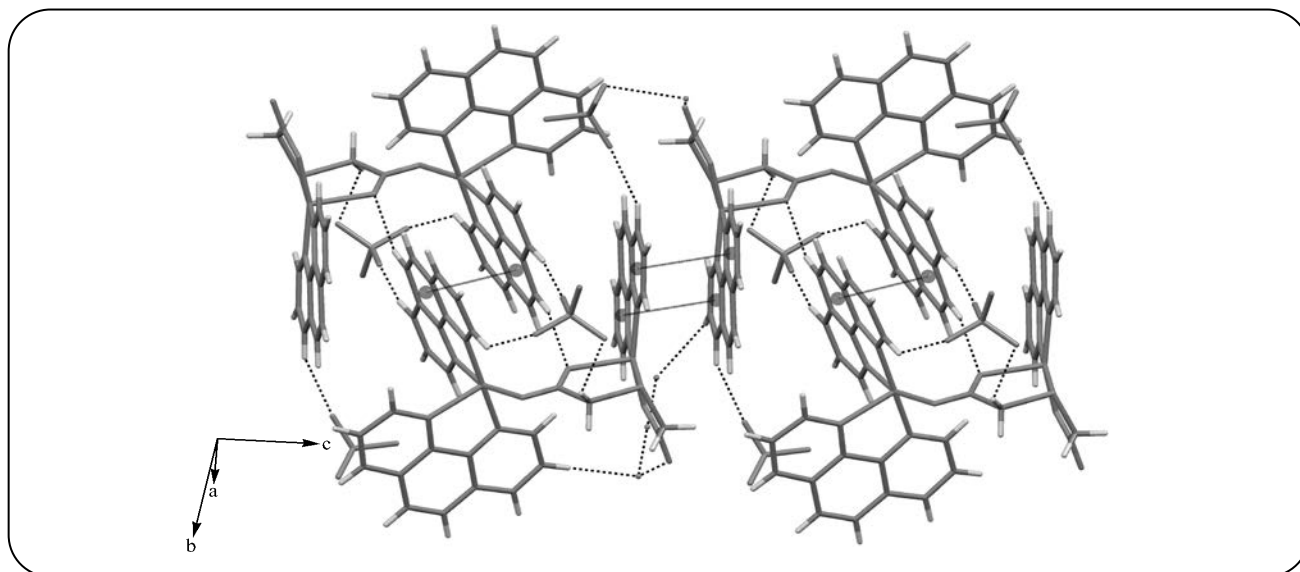

Fig. 5: Crystal packing diagram for $[(\text{phen})_2\text{Cu}(\mu\text{-tda})\text{Cu}(\text{phen})](\text{ClO}_4)_2 \cdot 1.5\text{H}_2\text{O}$ (**2**). Intermolecular interactions are shown as dashed lines.

group of the tda^{2-} are the bridging agents between the two coppers. Also, in these molecular chains, the shortest inter-metallic distance $\text{Cu1} \dots \text{Cu2}$ is 5.058 \AA . The Cu-N, Cu-O and Cu-S bond lengths and angles in complex **2** are in good agreement with the corresponding values $[(\text{phen})_2\text{Cu}(\mu\text{-tda})\text{Cu}(\text{phen})](\text{NO}_3)_2 \cdot 5\text{H}_2\text{O}$ [33].

In the crystal structure of **2**, Fig. 5, $\pi \dots \pi$ interaction between the phenyl and pyridine rings, $\text{Cg11} \dots \text{Cg12}^i$ and $\text{Cg14} \dots \text{Cg14}^{ii}$ [distance = $3.596(2)$ and $3.353(2) \text{ \AA}$, respectively, symmetry codes: (i) $1-x, 2-y, -z$ and (ii) $1-x, 2-y, 1-z$, Cg11, Cg12 and Cg14 are the centroids of (N5/C25-C29) ring, (N6/C32-C36) ring and (C13/C17-C20/C24) ring,

Table 6: Biological activity data for complexes 1, 2 and ligands. Inhibition zone (in mm) includes diameter of the disc (6 mM).

Bacteria	Complex 1		Complex 2		H ₂ tda	Phen
	%100	%60	%100	%60		
Staphylococcus aureus ATCC 25923	20.5±0.7	18±1.41	15.5±2.1	14±0	-	20±1.41
Acillus subtilis ATCC 456	21±1.41	18.5±0.7	18±0	15.5±0.7	-	23.5±0.7
Enterococcus faecalis ATCC 29727	23.5±0.7	19.5±0.7	19.5±0.7	14.5±0.7	-	16.5±0.7
Scherichia coli ATCC 25922	21.5±0.7	19±1.41	17±1.41	17.5±0.7	-	20.5±2.1
Klebsiella pneumoniae ATCC 10031	18.5±0.7	16±1.41	9±1.4	10±0	-	19±1.41
Pseudomonas aeruginosa ATCC 27853	13.5±2.1	9.5±0.7	-	9.5±0.7	-	10.5±0.7

respectively] and intermolecular C-H...O hydrogen bonds (Table S1) are effective in the stabilization of the crystal structure and formation of the 3-D supramolecular assembly.

Antimicrobial activity of complexes and ligands

The antibacterial activity of **1**, **2** and its main ligands were determined by the disc diffusion method (CLSI, 2011). Briefly, 0.1 mL of a suspension of the test microorganism (10^8 cells/mL) was spread on Mueller-Hinton agar plates, and sterile 6-mm discs, each containing 20 μ L of compounds, were placed on the microbial lawns. Discs containing 20 μ L of H₂tda and phen were also used to determine the antibacterial activity of the major complex components. The tests were carried out in duplicate, and plates were incubated at 37 °C for 24 h. The diameters of the inhibition zones were measured following the incubation period and reported in mm.

The results of the antibacterial activity determination of **1**, **2** and their ligands by disc diffusion are shown in Table 6. According to the disc diffusion method, all concentrations of **1** and **2** used were inhibitory for all reference bacterial strains (except complex **2** for *P. aeruginosa*). The inhibition zones ranged from 23.5-9 mm for the bacterial strains. The most susceptible organisms were the Gram-positive *B. subtilis*, *S. aureus* and *E. faecalis* with large inhibition zones even at the lowest content tested. As observed, complex **1** showed remarkable antibacterial activity compared to complex **2**. Among the ligands, only phen was inhibitory for all reference bacterial strains. These results may indicate that phen is the most active antibacterial compound among the two major complex ligands. Phen showed good antibacterial activity against *B. subtilis*, but were

moderately active against the other organisms tested. The strong biological activity of these compounds against reference bacterial strains suggests that the complex or its effective ligands may provide an alternative treatment for many bacterial infections [48].

CONCLUSIONS

Tow new copper(II) complexes of **1** and **2** have been synthesized in mixture of methanol/water at pH = 8 and 5, respectively. Compound **1** is a mononuclear complex and one thiodiacetate ligand coordinated to one Cu(II) atom from two oxygen atoms. However, compound **2** is a dinuclear complex and one thiodiacetate ligand coordinated to two Cu(II) atoms from three oxygen atoms. Thus, this work demonstrates a pH-dependent self-assembly system. The strong biological activities of these compounds were also investigated and suggest that these complexes or its effective ligands may provide an alternative treatment for many bacterial infections.

Acknowledgments

We would like to thank the Graduate Study Councils of Shahid Beheshti University for financial support.

Supplementary Material

Full crystallographic details are deposited with the Cambridge Structural Database (CCDC No 974709 for complex **1** and 974710 for complex **2**). Copies of the crystal data can be obtained free of charge on application to CCDC, 12 Union Road, Cambridge CB21EZ, UK.

Received : May 25, 2013 ; Accepted : Jun. 23, 2014

REFERENCES

- [1] Rao C.N.R., Natarajan S., Vaidhyanathan R., **Metal Carboxylates with Open Architectures**, *Angew. Chem. Int. Ed.*, **43**: 1466-1496 (2004).
- [2] Kitagawa S., Kitaura R., Noro S.I., **Functional Porous Coordination Polymers**, *Angew. Chem. Int. Ed.*, **43**: 2334-2375 (2004).
- [3] Hagrman P.J., Hagrman D., Zubieta J., **Organic-Inorganic Hybrid Materials: from "Simple" Coordination Polymers to Organodiamine-Templated Molybdenum Oxides**, *Angew. Chem. Int. Ed.*, **38**: 2638-2684 (1999).
- [4] Blake A.J., Champnees N.R., Hubberstey P., Li W.S., Withersby M.A., Schröder M., **Inorganic Crystal Engineering Using Self-Assembly of Tailored Building-Blocks**, *Coord. Chem. Rev.*, **183**: 117-138 (1999).
- [5] Moulton B., Zaworotko M.J., **From Molecules to Crystal Engineering: Supramolecular Isomerism and Polymorphism in Network Solids**, *Chem. Rev.*, **101**: 1629-1658 (2001).
- [6] Karimipour G., Montazerzohori M., Haghghat Naeini N., **Manganese (III)-Bis (Salicylaldehyde)-4-Methyl-1,2-Phenylenediamine (Mn-BSMP) as an Inexpensive N₂O₂ Type Schiff Base Catalyst for Oxidative Decarboxylation of Carboxylic Acids with (n-Bu₄NIO₄) in the Presence of Imidazol**, *Iran. J. Chem. Chem. Eng. (IJCCE)*, **30**: 13-18 (2011).
- [7] Piroozmand M., Safari N., Samadi A.A., **Catalyzed Oxidation of Cyclohexene and Cyclooctene with First Row Transition Metallophthalocyanines**, *Iran. J. Chem. Chem. Eng. (IJCCE)*, **25**: 85-89 (2006).
- [8] Mohajer, D., Tayebee, R. **Influence of Nitrogen Bases on Epoxidation of Cyclooctene with Sodium Periodate Catalyzed by Manganese (III) Porphyrins**, *Iran. J. Chem. Chem. Eng. (IJCCE)*, **18**: 27-29 (1999).
- [9] Thomas A.M., Nethaji M., Mahadevan S., Chakravarty A.R., **Synthesis, Crystal Structure, and Nuclease Activity of Planar Mono-Heterocyclic Base Copper(II) Complexes**, *J. Inorg. Biochem.*, **94**: 171-178 (2003).
- [10] Zhang L., Niu S.Y., Jin J., Sun L.P., Yang G.D., Yie L., **Preparation and Surface Photovoltage of Four Cu(II/I) Complexes**, *Chem. J. Chin. Universities.*, **30**: 236-240 (2009).
- [11] Solomon E.I., Sundaram U.M., Machonkin T.E., **Multicopper Oxidases and Oxygenases**, *Chem. Rev.*, **96**: 2563-2606 (1996).
- [12] Trofimenko S., **Recent Advances in Poly(Pyrazolyl)Borate (Scorpionate) Chemistry**, *Chem. Rev.*, **93**: 943-980 (1993).
- [13] Willet R.D., Gatteschi D., Kahn O., **"Magneto-Structural Correlations in Exchange Coupled Systems"**, Reidel, Dordrecht, p. 1 (1984).
- [14] O. Kahn, **"Molecular Magnetism"**, VCH Publishers, New York, p. 103 (1993).
- [15] Sigman D.S., Perrin D.M., **Chemical Nucleases**, *Chem. Rev.*, **93**: 2295-2316 (1993).
- [16] Schaeffer F., Rimsky S., Spassky A., **DNA-stacking Interactions Determine the Sequence Specificity of the Deoxyribonuclease Activity of 1,10-Phenanthroline-Copper Ion**, *J. Mol. Biol.*, **260**: 523-539 (1996).
- [17] Mahadevan S., Palaniandavar M., **Spectral and Electrochemical Behavior of Copper(II)-Phenanthrolines Bound to Calf Thymus DNA. [(5,6-dimethyl-OP)₂Cu]²⁺ (5,6-dimethyl-OP = 5,6-Dimethyl-1,10-phenanthroline) Induces a Conformational Transition from B to Z DNA**, *Inorg. Chem.*, **37**: 3927-3934 (1998).
- [18] Zoroddu M.A., Zanetti S., Pogni R., Basosi R., **An Electron Spin Resonance Study and Antimicrobial Activity of Copper(II)-Phenanthroline Complexes**, *J. Inorg. Biochem.*, **63**: 291-300 (1996).
- [19] Ranford J.D., Sadler P. J., Tocher D. A., **Cytotoxicity and Antiviral Activity of Transition-Metal Salicylato Complexes and Crystal Structure of Bis(Diisopropylsalicylato)(1,10-Phenanthroline) Copper(II)**, *J. Chem. Soc. Dalton Trans.*, 3393-3399 (1993).
- [20] Geraghty M., Sheridan V., McCanna M., Devereux M., McKeec V., **Synthesis and Anti-Candida Activity of Copper(II) and Manganese(II) Carboxylate Complexes: X-Ray Crystal Structures of [Cu(sal)(bipy)].C₂H₅OH.H₂O and [Cu(norb)(phen)₂].6.5H₂O (SalH₂=Salicylic Acid; NorbH₂=cis-5-Norbornene-Endo-2,3-Dicarboxylic Acid; Bipy= 2,2'-Bipyridine; Phen=1,10-Phenanthroline)** *Polyhedron.*, **18**: 2931-2939 (1999).

- [21] Saha D.K., Sandbhor U., Shirisha K., Padhye S., Deobagkar D., Ansond C.E., Powell A.K., **A Novel Mixed-Ligand Antimycobacterial Dimeric Copper Complex of Ciprofloxacin and Phenanthroline**, *Bioorg. Med. Chem. Lett.*, **14**: 3027-3032 (2004).
- [22] Alarcón-Payer C., Pivetta T., Choquesillo-Lazarte D., González-Pérez J., Crisponi G., Castiñeiras A., Niclós-Gutiérrez J., **Thiodiacetato-Copper(II) Chelates with or Without N- Heterocyclic Donor Ligands: Molecular and/or Crystal Structures of [Cu(tda)]_n, [Cu(tda)(Him)₂(H₂O)] and [Cu(tda)(5Mphen)].2H₂O (Him = imidazole, 5Mphen = 5- Methyl-1,10-Phenanthroline)**, *Inorg. Chim. Acta*, **358**: 1918-1926 (2005).
- [23] Amundsen A.R., Whelan J., Bosnich B., **Biological Analogs. Nature of the Binding Sites of Copper-Containing Proteins**, *J. Am. Chem. Soc.*, **99**: 6730-6739 (1977).
- [24] McCormick D.B., Griesser R., Sigel H. in "Metal Ions in Biological Systems", ed. Sigel H., Dekker, New York, 1, p. 213 (1974).
- [25] Warner L.G., Ottersen T., Seff K., **Synthesis and Crystal Structure of a Polymeric Copper(I) Aliphatic Disulfide Complex. [Bis[2-(2-Pyridyl)Ethyl]Disulfide] Copper(I) Perchlorate**, *Inorg. Chem.*, **13**: 2819-2826 (1974).
- [26] Braithwaite A.C., Rickard C.E.F., Waters T.N., **Imine Hydrolysis Reactions in Copper(II) Complexes of N,N'-Ethylenebis-(Thiophen-2-Carbalimine) and -(Pyridine-2-Carbalimine)**, *J. Chem. Soc. Dalton Trans.*, 2149-2153 (1975).
- [27] Chin Ou C., Miskowski V.M., Lalancette R.A., Potenza J.A., Schugar M.J., **Crystal and Molecular Structure of Bis[Beta-Methylmercaptoethylamine] Copper(II) Dipperchlorate**, *Inorg. Chem.*, **15**: 3157-3161 (1976).
- [28] Richardson J.F, Payne N.C., **Crystal and Molecular Structures of (1,8-Diamino-3,6- Dithiaoctane)(1-Methylimidazole)Copper(II) Perchlorate**, *Inorg. Chem.*, **17**: 2111-2114 (1978).
- [29] Karlin K. D., Dahlstrom P. L., Hyde J. R., Zubieta J., **Structural Comparison of Cu^I and Cu^{II} Complexes Displaying Analogous N₂S₂ co-Ordination; X-ray Analysis of Tetraco-Ordinate [Cu(pma)]BPh₄ and Pentaco-Ordinate [Cu(pma)SO₄] [pma=2-Pyridyl methyl bis-(2-Ethylthioethyl)Amine]**, *J. Chem. Soc., Chem. Commun.*, 906-908 (1980).
- [30] Merz L., Haase W., **Exchange Interaction in Tetrameric Oxygen-Bridged Copper(II) Clusters of the Cubane Type**, *J. Chem. Soc., Dalton Trans.*, 875-879 (1980).
- [31] Prochaska M.J., Schwindinger W.F., Schwartz M., Burk M.J., Bernarducci E., Lalancette R.A., Potenza J.A., Schugar H.J., **Characterization of Apical Copper(II)-Thioether Bonding. Structure and Electronic Spectra of Bis(2,2-bis(5-phenyl-2-imidazolyl)propane)copper(II) Dipperchlorate and Bis(1,3-bis(5-phenyl-2-imidazolyl)-2-Thiapropane) Copper(II) Dipperchlorate**, *J. Am. Chem. Soc.*, **103**: 3446-3455 (1981).
- [32] Jian F., Wang Z., Bai Z., You X., **Synthesis, Structural and Spectroscopic Characterization of the α and β Forms of Bis(imidazole) Copper(II) Dibenzoate, [Cu(im)₂(OBz)₂]**, *Transition Met. Chem.*, **24**: 589-594 (1999).
- [33] Kopel P., Trávníček Z., Marek J., Korabik M., **Syntheses and Properties of Binuclear Copper(II) Mixed-Ligand Complexes Involving Thiodiglycolic Acid.: The crystal Structures of [(phen)₂Cu(μ-tdga)Cu(phen)](NO₃)₂·5H₂O and [(H₂O)(pmdien)Cu(μ-tdga)Cu(pmdien) (H₂O)](ClO₄)₂**, *Polyhedron*, **22**: 411-418 (2003).
- [34] Stoe & Cie, "X-AREA, Version 1.30: Program for the Acquisition and Analysis of Data", Stoe & Cie GmbH, Darmstadt, Germany, (2005).
- [35] Stoe & Cie, "X-RED, Version 1.28b: Program for Data Reduction and Absorption Correction", Stoe & Cie GmbH, Darmstadt, Germany, (2005).
- [36] Stoe & Cie, "X-SHAPE, Version 2.05: Program for Crystal Optimization for Numerical Absorption Correction", Stoe & Cie GmbH, Darmstadt, Germany, (2004).
- [37] G. M. Sheldrick, "SHELX97. Program for Crystal Structure Solution and Refinement", University of Gttingen, Germany, (1997).
- [38] E. Prince (Ed.), "International Tables for X-ray Crystallography", vol. C, Kluwer Academic Publisher, Dordrecht, Netherlands, pp. 566-577 (2004).
- [39] Stoe & Cie, "X-STEP32, Version 1.07b: Crystallographic Package", Stoe & Cie GmbH, Darmstadt, Germany, (2000).

- [40] Thebo K., Shad H., Raftery J., Malik M., Mahmud T., O'Brien P., [Synthesis, Characterization and X-Ray Diffraction of \[Cu\(malonate\)\(phen\)\]₂·17H₂O Complex](#), *J. Mol. Struct.*, **1001**: 12-15 (2011).
- [41] Chen B.L., Mok K.F., Ng S.C., Feng Y.L., Liu S.X., [Synthesis, Characterization and Crystal Structures of Three Diverse Copper \(II\) Complexes with Thiophene-2,5-Dicarboxylic Acid and 1,10-Phenanthroline](#), *Polyhedron*, **17**: 4237-4247 (1998).
- [42] Ito K., Bernstein H. J., [The Vibrational Spectra of the Formate, Acetate, and Oxalate Ions](#), *Can. J. Chem.*, **34**: 170-178 (1956).
- [43] Selvakumar B., Rajendiran V., Uma Maheswari P., Stoeckli-Evans H., Palaniandavar M., [Structures, Spectra, and DNA-Binding Properties of Mixed Ligand Copper\(II\) Complexes of Iminodiacetic Acid: The Novel Role of Diimine Co-Ligands on DNA Conformation and Hydrolytic and Oxidative Double Strand DNA Cleavage](#), *J. Inorg. Biochem.*, **100**: 316-330 (2006).
- [44] Bush P.M., Whitehead J.P., Pink C.C., Gramm E.C., Eglin J. L., Watton S.P., Pence L.E., [Electronic and Structural Variation among Copper\(II\) Complexes with Substituted Phenanthrolines](#), *Inorg. Chem.*, **40**: 1871-1877 (2001).
- [45] Addison A.W., Rao T.N., Reedijk J., van Rijn J., Verschoor G. C., [Synthesis, Structure, and Spectroscopic Properties of Copper\(II\) Compounds Containing Nitrogen-Sulphur Donor Ligands; the Crystal and Molecular Structure of Aqua\[1,7-bis\(N-Methylbenzimidazol-2'-yl\)-2,6-Dithiaheptane\] Copper\(II\) Perchlorate](#), *J. Chem. Soc. Dalton Trans.*, **7**: 1349-1356 (1984).
- [46] Murphy G., Nagle P., Murphy B., Hathaway B., [Crystal Structures, Electronic Properties and Structural Pathways of Four \[Cu\(phen\)₂Cl\]\[Y\] Complexes \(Phen = 1,10-Phenanthroline; Y = BF₄⁻·0.5H₂O, PF₆⁻, CF₃SO₃⁻·H₂O or BPh₄⁻\)](#), *J. Chem. Soc., Dalton Trans.*, **15**: 2645-2652 (1997).
- [47] Bonomo R.P., Rizzarelli E., Bresciani-Pahor N., Nardin G., [Properties and X-Ray Crystal Structures of Copper\(II\) Mixed Complexes with Thiodiacetate and 2,2'-Bipyridyl or 2,2':6'2"- Terpyridyl](#), *J. Chem. Soc., Dalton Trans.*, **4**: 681-685 (1982).
- [48] Clinical and Laboratory Standards Institute (CLSI). [Performance Standards for Antimicrobial Susceptibility Testing; Twenty first informational Supplement](#). *Clin Lab Stand Inst.*, **31**(1): 1-165 (2011).