

Corrosion Protection of Copper with Hybrid Sol-Gel Containing 1H-1, 2, 4-triazole-3-thiol

Balaji, Jaqanathan; Sethuraman, Matur Gopalakrishnan*⁺

*Department of Chemistry, Gandhigram Rural Institute-Deemed University,
Gandhigram-624 302, Tamil Nadu, INDIA*

ABSTRACT: *To improve the corrosion protection of copper metal, 0.01M concentration of 1H-1,2,4-triazole-3-thiol (TAT) was incorporated into the hybrid sol-gel monolayers containing 3-glycidoxypropyltrimethoxysilane (GPTMS) and Tetraethoxysilane (TEOS). It was further subjected to hydrolysis and condensation reaction to form a sol-gel matrix. The TAT-doped hybrid sol-gel coating was applied over the copper surface by Self Assembled Monolayer (SAM) method. The resultant coating was characterized by Fourier Transform Infra red (FT-IR), X-Ray Diffraction (XRD) analysis, Scanning Electron Microscopy (SEM) and Energy-Dispersive X-ray (EDX) spectroscopy. The corrosion protection ability of these coatings was evaluated by Electrochemical Impedance Studies (EIS) and Potentiodynamic Polarization (PP) measurements in 3.5% NaCl medium. The EIS and PP results showed that TAT doped hybrid sol-gel coating exhibit better corrosion protection than the undoped hybrid coating alone. Thus these studies revealed the enhancement of corrosion protection of TAT doped hybrid sol-gel coating on the copper metal surface.*

KEYWORDS: *Sol-gel; Hybrid; Copper; Corrosion.*

INTRODUCTION

Copper is a material widely used in pipe lines for domestic and industrial utilities due to its high thermal, electrical conductivity and good mechanical workability. Even though copper has high standard electrode potential, corrosion occurs at a significant rate in sea water and chloride environments [1-11]. Therefore surface protection is needed to improve the life of copper [12]. Organic compounds like azoles have shown high efficiency for corrosion protection of copper and its alloys in different environments [13-14].

Extensive research is in progress on the topic of Self-Assembled Monolayers (SAMs) in recent years, because

of both their fundamental importance in understanding interfacial properties, as well as due to their potential applications in technology [15-17]. SAM method has been widely used to prepare the compact monolayers because of its several advantages [18]. SAM has potential application in aqueous solution due to its dense and stable structure. Formation of SAM is mainly based on spontaneous adsorption of molecules with polar head groups which bind specifically and chemically to the metal surface [19]. Organic compounds containing nitrogen, sulphur, oxygen and heterocyclic group with conjugated double bonds have been reported to inhibit copper corrosion [20-22].

* To whom correspondence should be addressed.

+ E-mail: mgsethu@gmail.com

1021-9986/2016/4/61

11/\$/6.10

Sol-gel coating technique is mainly based on hydrolysis and condensation reactions. Sol-gel coatings are employed with their increasing frequency because of its low cost, simple and environmentally safe method. Sol-gel coating has several advantages and it protects the metal surface from wide range of temperatures [23]. In copper metal surface epoxy functionalized sol-gel coating does not provide good anticorrosion performance because it is difficult to form Cu-O-Si bond. Hence to obtain good anticorrosion sol-gel coating thiol functionalized group was used to form stable Cu-S bond on copper surface [24-26].

In the present study, hybrid monolayers consisting of GPTMS and TEOS were used as the chemical precursors for sol-gel coating on copper electrode for corrosion protection. 0.01M concentration of 1H-1,2,4-triazole-3-thiol was incorporated into sol-gel matrix to improve the protective properties of hybrid monolayers. These coatings are characterized by FT-IR, XRD, SEM and EDX. The corrosion protection ability was evaluated by using electrochemical impedance spectroscopy and potentiodynamic polarization techniques in 3.5% NaCl medium.

EXPERIMENTAL SECTION

Chemicals

1H-1,2,4-triazole-3-thiol (TAT) (97%), 3-glycidoxypropyltrimethoxysilane (GPTMS) (98%) were purchased from Sigma-Aldrich and Tetraethoxysilane (TEOS) was purchased from Alfa-Aesar (98%). Ethanol and sodium chloride were used of analytical grade. 1H-1,2,4-triazole-3-thiol (TAT), 3-glycidoxypropyltrimethoxysilane (GPTMS) and Tetraethoxysilane (TEOS) solutions were prepared using ethanol. Electrochemical test solution was prepared with double distilled water.

Pretreatment of electrode

The working copper electrode (copper - 99%) of area 1.0 cm^2 was shaped as a cylindrical disc. The electrodes were successively polished with various grades of emery paper (#1, #2, #3, #4 and #5) and $0.3 \mu\text{m}$ alumina until the shiny mirror-like finish on the electrode surface. Then the electrodes were rinsed with double distilled water first and then with ethanol. Finally, the electrodes were treated

in ultrasonic bath with acetone for 10 min and dried in an air stream [27].

Preparation of sol-gel coating and formation of self-assembled monolayers

In order to prepare hybrid coating, hybrid sol containing 0.1M GPTMS and 0.1M TEOS were adjusted to pH 4.0 by the addition of 0.5M HCl and continuously stirred for 8 h to promote hydrolysis and condensation reactions [28].

TAT-doped hybrid sol-gel coating was prepared by mixing 0.01M TAT, 0.1M GPTMS and 0.1M TEOS (2:2:1 ratio) in a reaction vessel and the was mechanically stirred for 2 h. Then pH of the resulting solution was reduced from 6.3 to 4.0 by the addition of 0.5M HCl and the stirring continued for another 6 h. The pretreated copper electrode was rinsed with ethanol, dried and then immersed in sol-gel solution by Self-Assembled Monolayer (SAM) method for 12 h. For comparative study, the experiments were repeated by self-assembling hybrid monolayers and also with 0.01M TAT alone. Then the modified electrodes washed with ethanol to remove the physically adsorbed molecules. Finally, the modified substrates were dried for 1 h at $100 \text{ }^\circ\text{C}$ in a hot air oven.

Characterization of sol-gel coating

The sol-gel coating was removed by scratching the Cu surface and pelletized with KBr at room temperature and the Fourier Transform Infra red (FT-IR) spectrum was recorded with JASCO FT-IR 460 plus instrument in the absorption range of $4000\text{-}400 \text{ cm}^{-1}$. The coated copper surface was also examined using X-Ray Diffraction (XRD) analysis using a Philips X'pert pro X-ray diffractometer, with the working condition as Cu $K\alpha$ Ni-filtered radiation; divergence slit 0.47° . The surface morphology of bare and coated copper surface was analyzed by Scanning Electron Microscopy (SEM) VEGA 3 TESCAN model. Energy-Dispersive X-ray (EDX) spectroscopy was used to characterize the element present in the sol-gel coating over Cu metal using Bruker Nano GmbH, X Flash Detector 5010 model, Germany.

Evaluation of corrosion protection of sol-gel coating.

The electrochemical measurements were carried out using CHI 760D electrochemical workstation with CHI 760D operating software (CH Instruments Inc).

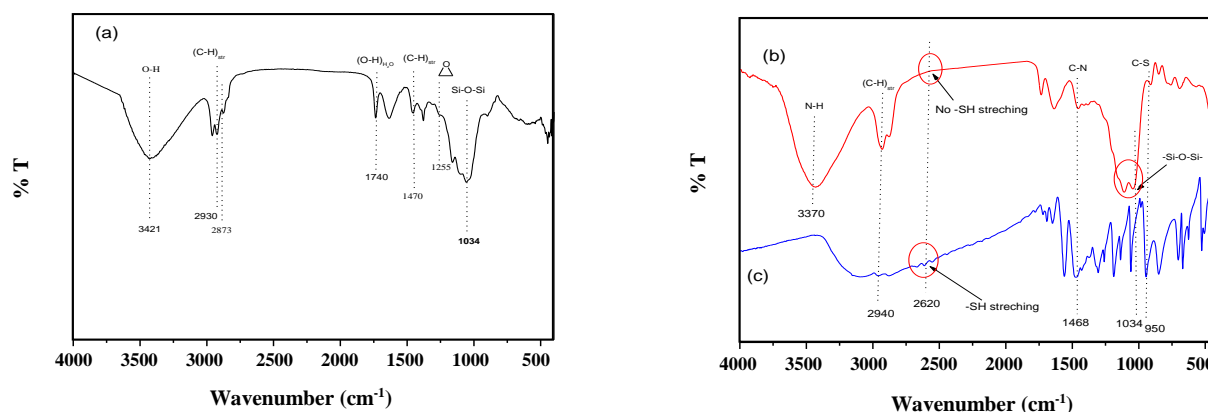

Fig. 1: FT-IR spectra of (a) Hybrid Coated, (b) 0.01 M TAT-doped Hybrid, (c) TAT coated, on Cu electrode.

Electrochemical Impedance Studies (EIS)

The EIS measurements were carried out for bare copper, hybrid coated, TAT coated, TAT-doped hybrid sol-gel coating on copper electrode in a three electrode system using the bare copper/modified copper as working electrodes. Saturated calomel electrode was used as reference electrode and platinum wire was used as counter electrode. The impedance measurements were carried out with the frequency range of 100 kHz to 0.1 Hz with an ac amplitude of 5 mV at Open Circuit Potential (OCP). The impedance plot was acquired using Zsimpwin 3.21 Software.

The inhibition efficiency (η) was calculated by R_{ct} values;

$$\eta (\%) = \frac{R_{ct} - R_{ct}^0}{R_{ct}} \times 100 \quad (1)$$

where R_{ct} is the charge transfer resistance value for coated copper electrodes and R_{ct}^0 is the charge transfer resistance for bare copper electrode.

Potentiodynamic polarization measurements

Potentiodynamic polarization measurements were carried out for bare copper, hybrid coated, TAT coated and TAT-doped hybrid sol-gel coating on copper electrodes at the scan rate of 1mV/S using the electrochemical work station and three electrode cell assembly. The inhibition efficiency (η) was calculated from the following relationship using i_{corr} values.

$$\eta(\%) = \frac{(i_{corr}^0 - i_{corr})}{i_{corr}^0} \times 100 \quad (2)$$

where i_{corr} is the corrosion current density value for coated copper electrodes and i_{corr}^0 is the corrosion current density value for bare copper electrode.

RESULTS AND DISCUSSION

FT-IR studies

The FT-IR spectrum of TAT-doped hybrid coated was compared with hybrid coated and pure TAT. Fig. 1. shows the FT-IR spectra of (a) hybrid coated, (b) TAT-doped hybrid sol-gel coating on copper metal and (c) pure TAT. In Fig.1a, hybrid coated specimen showed an absorption band at 3421 cm^{-1} which was due to O-H stretching, bands at 2930 cm^{-1} and 2873 cm^{-1} were due to alkyl hydrogen stretching and its corresponding bending vibration was seen at 1470 cm^{-1} . The stretching frequency band at 1255 cm^{-1} was due to ring breathing associated with epoxy ring which confirmed the presence of epoxy group [29]. The band at 1740 cm^{-1} could be attributed to the bending vibration of the absorbed water molecules [30]. The band at 1034 cm^{-1} for -Si-O-Si- bond formation confirmed the hydrolysis and condensation reactions of hybrid sol-gel coating.

In Fig.1b, the FT-IR spectra of pure TAT was compared with TAT-doped hybrid sol-gel coating on copper metal. The characteristic bands of pure TAT (band b) appeared at 3370, 2940, 1468 and 950 cm^{-1} which were attributed to the stretching vibrations of N-H, C-H, C-N and C-S bonds, respectively [31]. TAT-doped hybrid sol-gel coating in its IR (band c), showed all the characteristic bands of pure TAT except the bands at 2620 cm^{-1} . The band at 2620 cm^{-1} was not observed in TAT-doped hybrid sol-gel coating due to the formation

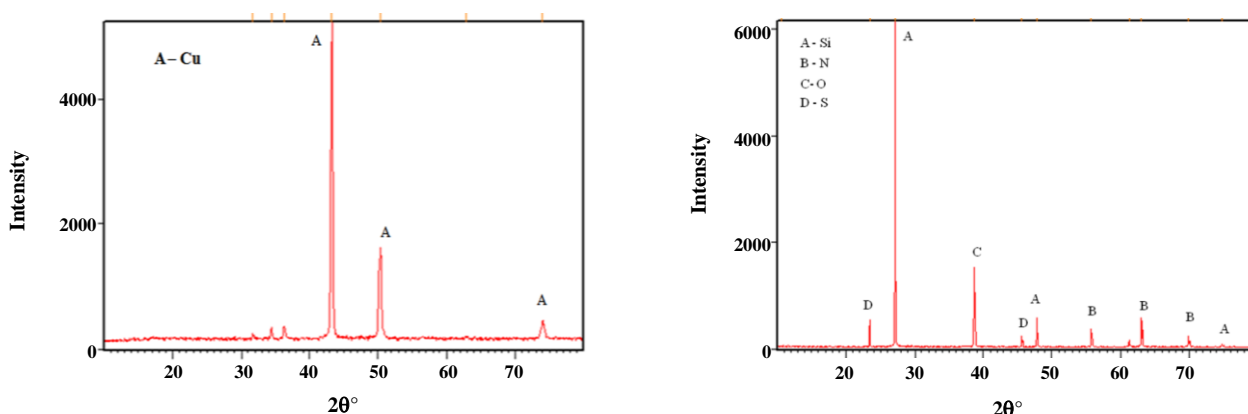

Fig. 2: XRD pattern of (a) Bare Copper, (b) TAT-doped Hybrid on Cu electrode.

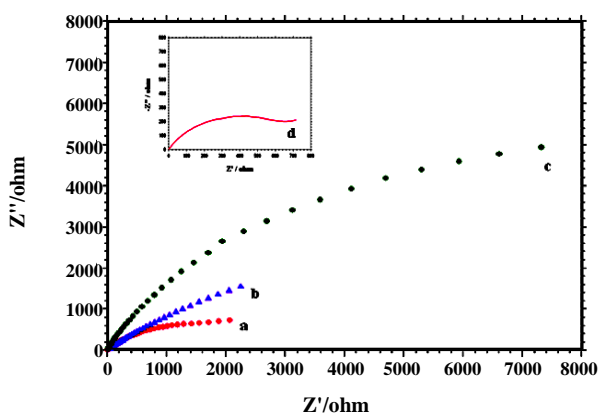

Fig. 3: Nyquist plots for (a) Hybrid Coated, (b) TAT coated, (c) 0.01 M TAT-doped Hybrid, on Cu electrode, inset: (d) Bare Cu in 3.5% NaCl medium.

of stable Cu-S bond [30]. The additional band at 1034 cm^{-1} was observed in TAT-doped hybrid which was due to the formation of $-\text{Si-O-Si}-$ bond which also confirmed the presence of sol-gel coating on copper surface.

X-Ray Diffraction (XRD) analysis

The XRD patterns of bare Cu and TAT-doped Hybrid sol-gel coating over the Cu surface are shown in Fig. 2 (a and b). Cu metal on exposure to air forms Cu_2O as evident from the peaks at 34° and 36° and the peaks at $2\theta = 43^\circ, 50^\circ$ and 74° correspond to Cu sub-layer of metal substrate [32]. In the case of TAT-doped Hybrid sol-gel coating over Cu metal, the peaks appeared at $2\theta = 23^\circ, 27^\circ, 48^\circ, 75^\circ$ correspond to Si and the peak appeared at $2\theta = 28^\circ$ correspond to S, which clearly confirmed the sol-gel coating on copper surface [33]. Thus the absence

of copper oxide peak and the presence of Si and S peaks in the FT-IR spectra of TAT-doped Hybrid sol-gel coated Cu metal clearly confirmed the sol-gel coating.

EIS measurements

EIS is one of the most intensively used techniques for the prediction of anti-corrosion activities and also used to evaluate the electrochemical interactions between the metal surface and the electrolyte solution [34]. The impedance data are useful in the determination of the surface coverage of the coated electrodes. Impedance studies of bare Cu electrode, hybrid coated on Cu electrode, TAT coated on Cu electrode and 0.01M TAT-doped hybrid sol-gel coating on the Cu electrode were carried out in 3.5% NaCl medium. The Nyquist diagram for bare Cu electrode, hybrid coated on Cu electrode, TAT coated on Cu electrode and 0.01M TAT-doped hybrid sol-gel coating on the Cu electrode are shown in Fig. 3 (a, b, c, d). In bare copper, the Warburg impedance observed in low frequency regions indicated that the diffusion process is controlled by the cathodic diffusion of dissolved oxygen from bulk solution to the electrode surface and anodic diffusion of soluble copper species (CuCl_2) from electrode surface to bulk solution.[35, 36].

The impedance values for bare copper electrode, hybrid coated, TAT coated and 0.01M TAT-doped hybrid sol-gel coating on the Cu electrode are shown in Table 1. The impedance parameters of bare Cu and coated copper electrodes are obtained using two different equivalent circuit models (Fig. 4 a and b), where R_s represents the solution resistance, R_t is the charge transfer resistance corresponding to the corrosion reaction at copper

Table 1: Electrochemical impedance parameters for bare copper, Hybrid coated and TAT-doped Hybrid sol-gel coating on copper electrode in 3.5% NaCl medium.

Impedance parameters	Bare	Hybrid coated	TAT Coated	0.01 M TAT + Hybrid Coated
R_s ($\Omega \text{ cm}^2$)	0.2236	7.987	1.686	17.61
W ($\Omega \text{ cm}^2 \text{ s}^{-0.5}$)	167.5	-	-	-
Q_{sam} ($\mu\text{F cm}^2$)	-	178.7	45.98	0.3696
$n1$	-	0.4836	0.491	0.9968
R_{sam} ($\Omega \text{ cm}^2$)	-	2.532	0.4174	27.35
Q_{dl} ($\mu\text{F cm}^2$)	166.3	7.531	64.91	16.07
$n2$	0.7197	0.8217	0.4992	0.6656
R_t ($\Omega \text{ cm}^2$)	642.1	3160	10848	16767
η (%)	-	79.68	94.08	96.17

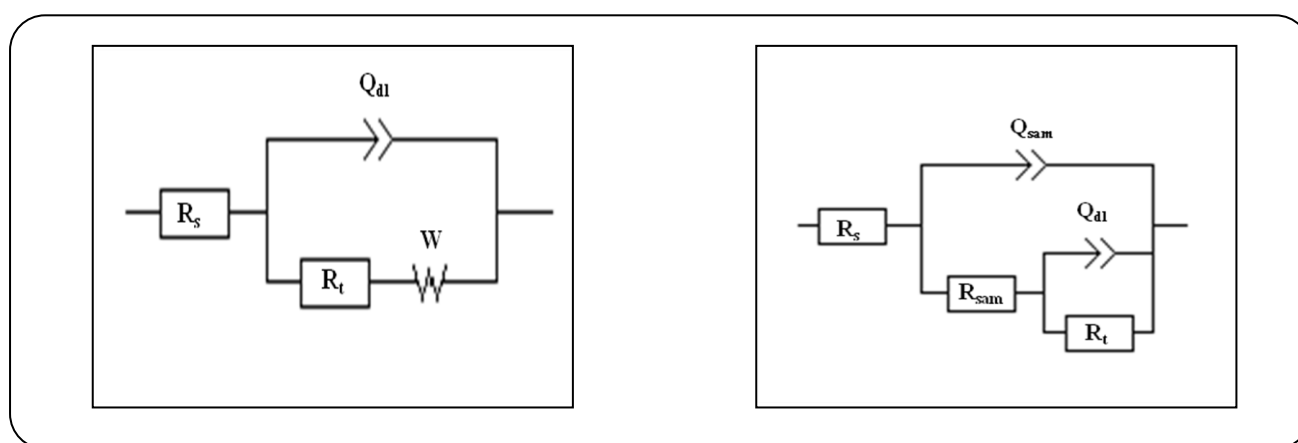

Fig. 4: Equivalent Circuit Models a) Bare Cu circuit b) Coated copper circuit.

interface, Q_{dl} is the constant phase elements (CPE) which is substituted for double layer capacitance (C_{dl}). Q_{sam} represents the capacitance of the coating and R_{sam} represents the charge transfer resistance through coated layer [37].

The Nyquist plots of coated copper electrodes by SAM method are quite different from these of bare copper electrode. The Warburg impedance which is observed in low frequency regions disappeared for coated copper electrodes indicates the formation of sol-gel coating over copper surface, which prevent the diffusion of corrosive species onto the copper substrate [38]. From the Table 1, it is clear that the charge transfer resistance values increased for 0.01M TAT-doped hybrid sol-gel coating on Cu electrode compared to the bare copper, hybrid coated, TAT coated Cu electrodes. The 0.01M

TAT-doped hybrid sol-gel coating on Cu electrode showed the inhibition efficiency (η) to be 96.17%. Thus TAT-doped Hybrid sol-gel coating forms a densely packed monolayer over copper surface is mainly due to the formation of thiolate bond by copper followed by a extended silane linkage which protects the copper from corrosion.

Potentiodynamic polarization studies

The potentiodynamic polarization curves for bare copper electrode, hybrid coated, TAT coated and 0.01 M TAT-doped Hybrid sol-gel coatings on Cu electrode in 3.5% NaCl solution are shown in Fig. 5 (a, b, c, d). The i_{corr} values for bare copper electrode is $46.2 \mu\text{A cm}^{-2}$ and while i_{corr} values was significantly reduced to $1.60 \mu\text{A cm}^{-2}$ for 0.01 M TAT-doped hybrid sol-gel coating on copper electrode.

Table 2: Potentiodynamic polarization parameters for bare copper, Hybrid coated, TAT coated and TAT-doped Hybrid sol-gel coating on copper electrode in 3.5% NaCl medium.

Nature of sol-gel coating	E_{corr} (mV)	i_{corr} ($\mu\text{A cm}^{-2}$)	b_a (mV)	b_c (mV)	η (%)
Bare Cu	-164	46.2	234	210	-
Hybrid coated	-266	19.7	126	397	57.35
TAT coated	-282	3.9	147	189	91.55
0.01 M TAT – Hybrid coated	-224	1.6	37	417	96.53

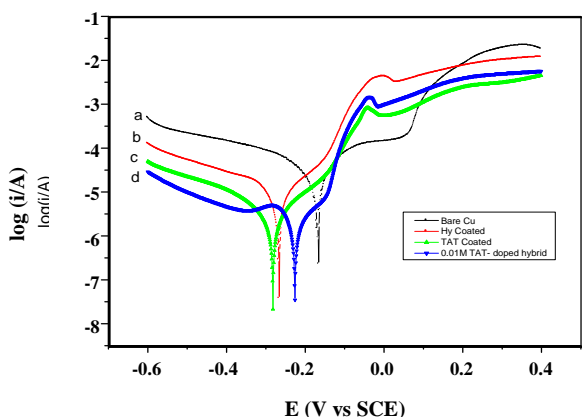
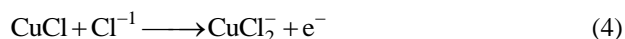

Fig. 5: Polarization curve for (a) bare Cu, (b) Hybrid coated, (c) TAT-coated, (d) 0.01 M TAT-doped Hybrid on Cu electrode in 3.5% NaCl medium.

This shows the enhanced protective efficiency TAT-doped hybrid sol-gel coating on copper electrode. The E_{corr} value for bare copper electrode is -164 mV. There is a significant change in E_{corr} for 0.01 M TAT-doped hybrid sol-gel coating on Cu electrode with the shifting of potential value negatively to -224 mV. From these observations, it is revealed that cathodic reaction of corrosion process is controlled more effectively by TAT-doped hybrid sol-gel coating on Cu electrode in 3.5% NaCl solution [39]. The SAM formed on the copper surface acts as an effective barrier for the diffusion of oxygen from the solution to the copper surface, thereby resisting the transfer of oxygen to the cathodic sites of the copper surface. [40]. The i_{corr} and E_{corr} values for bare Cu electrode, hybrid coated on Cu electrode, 0.01M TAT coated and 0.01 M TAT-doped hybrid sol-gel coating on Cu electrode in 3.5% NaCl solution are shown in Table 2. Thus it is concluded that 0.01M concentration of TAT-doped hybrid sol-gel coating on Cu electrode reduces the corrosion current and also shifted the corrosion potential of copper cathodically which can be seen from fig. 4.

Thus the main advantage of TAT-doped hybrid sol-gel coating is that higher corrosion protection efficiency can be achieved even at very low concentration. Thus the EIS and Potentiodynamic polarization studies revealed the formation of 0.01M TAT-doped Hybrid sol-gel coating on Cu electrode with significant corrosion resistant property.

The anodic dissolution of copper in neutral medium has been studied extensively. The mechanism of dissolution can be represented by the following reactions [41].



The CuCl formed on copper surface has weak adhesion and is further attacked by Cl^- to form a soluble cuprous chloride complex (CuCl_2^-) [42]. The cathodic reaction is enhanced due to the presence of oxygen in a neutral environment and the corresponding reaction takes place as follows [41].



The formation of protective monolayers over the copper surface inhibits the cathodic oxygen diffusion process, which was evident from the shifting of E_{corr} values towards the cathodic side to a large extent.

Scanning Electron Microscopic analysis

The SEM images of bare Cu, hybrid coated, TAT-doped hybrid sol-gel coating in 3.5% NaCl medium are shown in Fig. 6 (a-f). From the comparison of images, it is obvious that the TAT-doped hybrid sol-gel coating forms a very protective adhesive layer on copper in 3.5% NaCl medium. In addition to that, the EDX spectrum of bare Cu, hybrid coated, TAT-doped Hybrid sol-gel coating on Cu surface is depicted in Fig. 7 (a-c). In bare Cu,

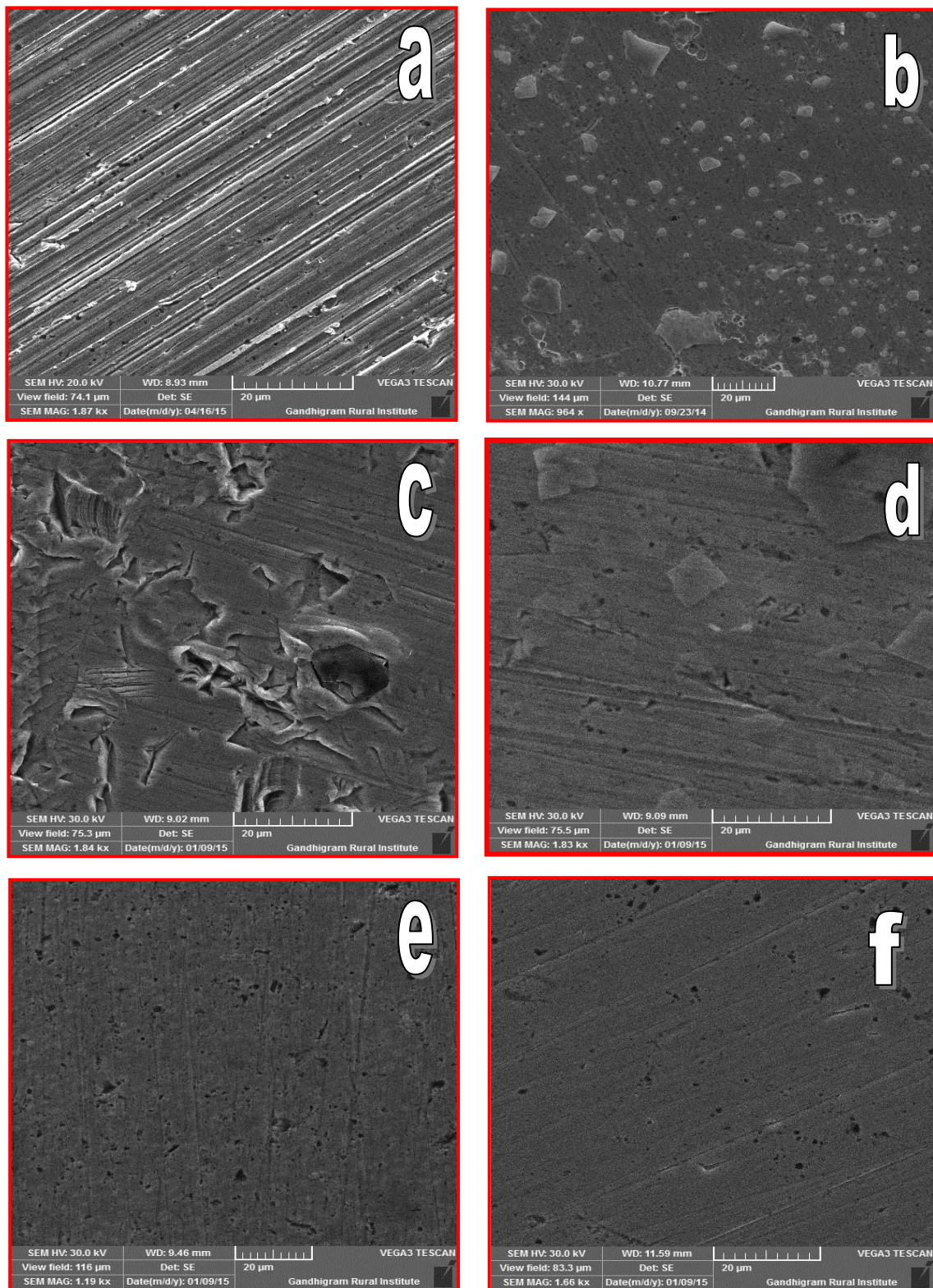

Fig. 6: SEM Images of (a) bare Cu, (b) bare Cu in 3.5 % NaCl (c) Hybrid coated, (d) Hybrid coated in 3.5 % NaCl, (e) 0.01 M TAT-doped Hybrid coated, (f) 0.01 M TAT-doped Hybrid coated on Cu electrode in 3.5% NaCl medium.

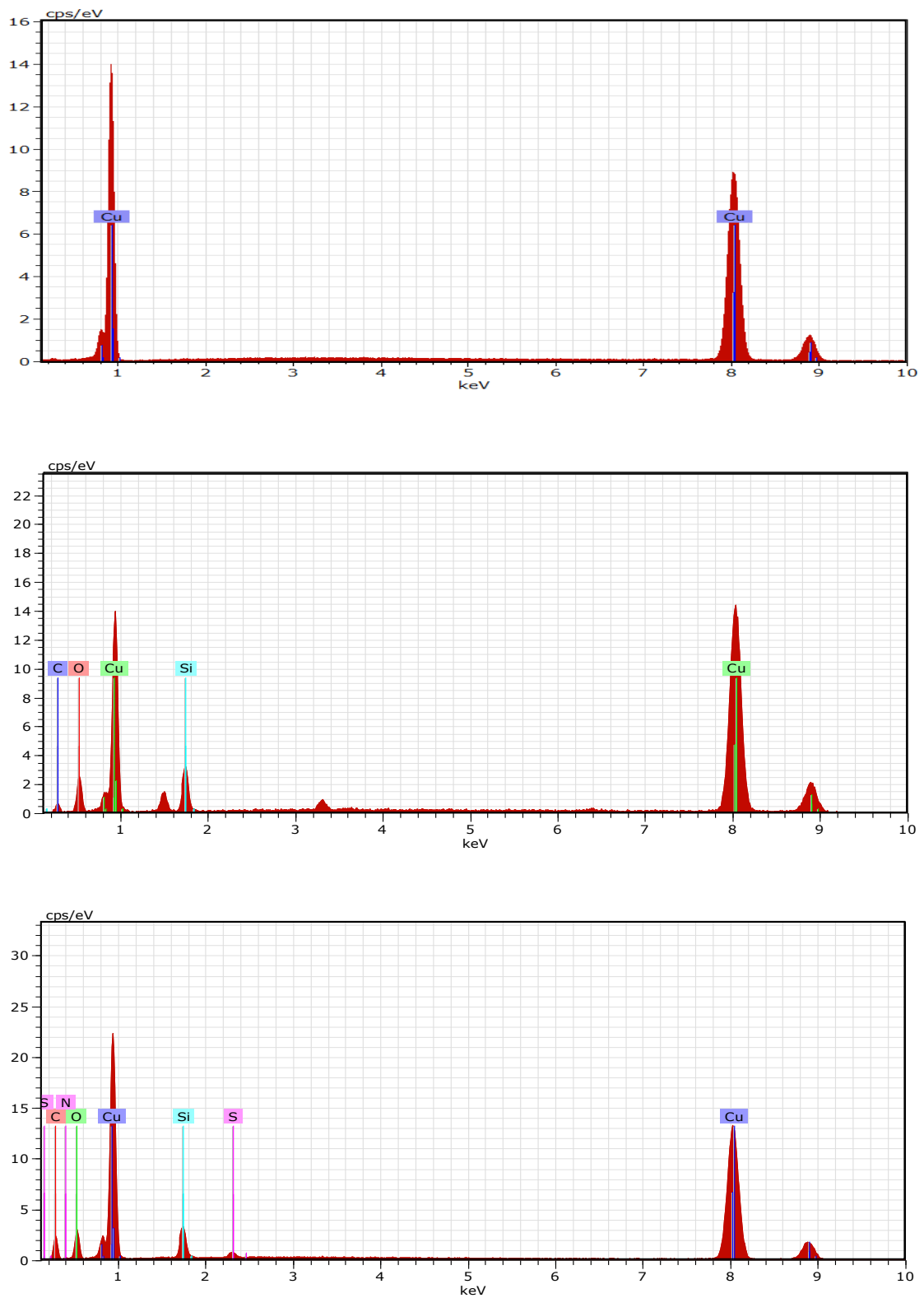

Fig. 7: EDX spectra of a) bare Cu (b) Hybrid coated c) TAT-doped Hybrid coated on Cu electrode.

peaks were obtained at 0.9 keV and 8 keV, while the hybrid coated surface showed that the presence of C (3.37 keV), O (3.31 keV), Si (0.38 keV). Besides, the EDX spectrum of TAT-doped hybrid sol-gel coating on Cu surface clearly revealed the peaks of N (1.40 keV), S (2.32 keV). Thus the protective ability of TAT-doped hybrid sol-gel coating over Cu surface was confirmed by SEM images and EDX analysis confirmed the doped sol-gel coating over the copper electrodes.

Mechanism

The schematic representation of 0.01M TAT-doped hybrid sol-gel coating on Cu electrode surface is shown in Fig. 5. By the addition of TAT with hybrid sol, the acidic carbon in epoxy ring undergoes nucleophilic attack by the lone pair of electrons present in nitrogen. Then the epoxy ring opening occurs by the transfer of electrons from carbon to oxygen. The electron-rich oxygen atom attracts the hydrogen in the amine molecule and the rearrangement takes place [43]. After the hydrolysis by the addition of HCl, condensation reactions occurred to produce Si-O-Si bond formation during gelation. The prepared sol-gel was grafted onto Cu metal by SAM method for 12 h to form Cu-S bond which form a stable sol-gel coating over the copper surface and protect it from corrosion.

CONCLUSIONS

The study reveals the efficacy of Hy sol-gel coating in the protection of copper in the hostile environment. Further the doping of 0.01M concentration of TAT into the sol-gel network substantially increases the protection performance. The formation of SAM of TAT-doped hybrid sol-gel coating on Cu electrode was confirmed by FT-IR, XRD, SEM and EDAX analyses. The corrosion protection efficiency of TAT-doped hybrid sol-gel coating on Cu electrode was confirmed by EIS and potentiodynamic polarization studies. Thus TAT, being a proven corrosion inhibitor, can enhance the protection of the metallic surface by the formation of thiolate bond between copper and TAT results in the formation of dense, compact coating through the silane linkage over metal and thus leading to a smart/intelligent coating.

Acknowledgment

One of the authors (J.Balaji) is thankful to UGC-RFSMS (Research Fellowship in Sciences for Meritorious

Students) for its financial assistance and both the authors thank UGC-SAP for their support and authorities of GRI for their encouragement.

Received : Aug. 11, 2015 ; Accepted : Mar. 1, 2016

REFERENCES

- [1] Sherif E.M., Erasmus R.M., Comins J.D., [Corrosion of Copper in Aerated Synthetic Sea Water Solutions and Its Inhibition by 3-Amino-1, 2, 4-Triazole](#), *Journal of Colloid Interface Science*, **309**:470-477 (2007)
- [2] Otmacic H, Telegdi J, Papp K, Stupnisek-Usac E., [Protective Properties of an Inhibitor Layer Formed on Copper in Neutral Chloride Solution](#), *J. Appl Electrochem*, **34**: 545-550 (2004)
- [3] Sherif E.M, Park S.M., [Electrochemical Behavior of Copper in Borax Buffer Solution in the Presence of 1-Phenyl-5-Mercapto Tetrazole](#), *J. Electrochem. Soc.*, **152**: B428-B433 (2005)
- [4] Curkovic H.O, Stupnisek-Lisac E, Takenouti H., [The Influence of pH Value on the Efficiency of Imidazole Based Corrosion Inhibitors of Copper](#), *Corros. Sci*, **52**: 398-405 (2010)
- [5] Szocs E, Vastag G, Shaban A, Kalman E., [Electrochemical Behaviour of an Inhibitor Film Formed on Copper Surface](#), *Corros. Sci*, **38**: 2019-2029 (1996)
- [6] Sherif E.M, Park S.M., [2-Amino-5-ethyl-1, 3, 4-Thiadiazole as a Corrosion Inhibitor for Copper in 3.0% NaCl Solutions](#), *Corros. Sci.*, **48**: 4065-4079 (2006).
- [7] Finsgar M, Milosev I, Pihlar B., [Inhibition of Copper Corrosion Studied by Electrochemical and EQCN Techniques](#), *Acta Chimica Slovenica*, **54**: 591-597 (2007).
- [8] Amin M.A., [Weight Loss, Polarization, Electrochemical Impedance Spectroscopy](#), *J. Appl Electrochem*, **36**: 215-226 (2006).
- [9] Ismail K.M., [Electrochemical Preparation and Kinetic Study of Poly \(o-Tolidine\) in Aqueous Medium](#), *Electrochim. Acta*, **52**: 3883-3888 (2007)
- [10] Biswas B.N, Mollah M.Y.A, Susan M.A.B.H., [Potentiodynamic Studies on Corrosion of Copper by Chloride Ions and Its Inhibition by Inorganic and Organic Ions in Aqueous Buffer Solution](#), *Ionics*, **18**: 189-195 (2012)

- [11] Liang C, Wang P, Wu B, Huang N., **Inhibition of Copper Corrosion by Self-Assembled Monolayers of Triazole Derivative in Chloride-Containing Solution**, *J. Solid State Electrochem*, **14**: 1391-1399 (2010).
- [12] Sorensen P.A, Kiil S, Dam-Johansen K, Weinell C.E., **Anticorrosive Coatings: A Review**, *J. Coat. Technol. Res.*, **6**: 135-146 (2009).
- [13] Huynh N., Bottle S.E., Notoya T., Schweinsberg D.P., **Inhibitive Action of the Octyl Esters of 4-and 5-Carboxybenzotriazole for Copper Corrosion in Sulphate Solutions**, *Corros. Sci.*, **42**: 259-274 (2000).
- [14] Antonijevic M.M, Milic S.M, Serbula S.M, Bogdanovic G.D., **The Influence of Chloride Ions and Benzotriazole on the Corrosion Behavior of Cu37Zn Brass in Alkaline Medium**, *Electrochim. Acta.*, **50**: 3693-3701 (2005).
- [15] Ulman. A., "An Introduction to Ultrathin Organic Films, From Langmuir-Blodgett to Self Assembly", Academic Press: Boston (1991).
- [16] Swalen J.D., Allara D.L., Andrade J.D., Chandross E.A., Garof S., Israelachvili J., McCarthy T.J., Murray R., Pease R.F., Rabolt J.F., Wynne Y.H., **Molecular Monolayers and Films. A Panel Report for the Materials Sciences Division of the Department of Energy**, *Langmuir*, **3**: 932-950 (1987).
- [17] Zhang D.Q, Gao L.X, Cai Q.R, Lee K.Y., **Inhibition of Copper Corrosion by Modifying Cysteine Self-Assembled Film with Alkylamine/Alkylacid Compounds**, *Mater. Corros.*, **61**: 16-21 (2010).
- [18] Li G.Y., Ma H.Y., Jiao Y.L., Chen S.H., **An Impedance Investigation of Corrosion Protection of Copper by Self-assembled Monolayers of Alkanethiols in Aqueous Solution**, *J. Serb. Chem. Soc.*, **69**: 791-805 (2004).
- [19] Chen W., Hong S., Bing Li H., Luo H.Q., Li M., Li N.B., **Protection of Copper Corrosion in 0.5 M NaCl Solution by Modification of 5-Mercapto-3-Phenyl-1, 3, 4-Thiadiazole-2-Thione Potassium self-Assembled Monolayer**, *Corros Sci.*, **61**: 53-62 (2012).
- [20] Sherif E.M, Park S.M., **Inhibition of Copper Corrosion in Acidic Pickling Solutions by N-Phenyl-1, 4-Phenylenediamine**, *Electrochim. Acta.*, **51**: 4665-4673 (2006)
- [21] Zucchi F., TrabANELLI G., Fonsati M., **Tetrazole Derivatives as Corrosion Inhibitors for Copper in Chloride Solutions**, *Corros. Sci.*, **38**: 2019-2029 (1996).
- [22] Antonijevic M.M, Petrovic M.B., **Copper Corrosion Inhibitors. A Review**, *Int. J. of Electrochem. Sci.*, **3**: 1-28 (2008).
- [23] Kim H, wang T.H., **Corrosion Protection Enhancement Effect by Mixed Silica Nanoparticles of Different Sizes Incorporated in a Sol-Gel Silica Film**, *J. Sol-Gel Sci Technol.*, **63**: 563-568 (2012).
- [24] Zheng S.X, Li J.H., **Inorganic-Organic Sol Gel Hybrid Coatings for Corrosion Protection of Metals**, *J. Sol-Gel Sci Technol.*, **54**: 174-187 (2010).
- [25] Zucchi F., Grassi V., Frignani A., TrabANELLI G., **Inhibition of Copper Corrosion by Silane Coatings**, *Corros. Sci.*, **46**: 2853-2865 (2004).
- [26] Laibinis P.E, Whitesides G.M, Allara D.L, Tao Y.T, Parikh A.N, Nuzzo R.G., **Comparison of the Structures and Wetting Properties of Self-Assembled Monolayers of n-Alkanethiols on the Coinage Metal Surfaces, Copper, Silver, and Gold**, *J. Am. Chem. Soc.*, **113**: 7152-7167 (1991)
- [27] Balaji J., Sethuraman M.G., **Corrosion Protection of Copper with 3-Glycidoxypropyltrimethoxysilane-Based Sol-Gel Coating Through 3-Amino-5-Mercapto-1,2,4-Triazole Doping**, *Res. Chem. Intermed.*, DOI: 10.1007/s11164-015-2087-1, (2015).
- [28] Karthik N., Asha S., Sethuraman M.G., **Influence of pH-Sensitive 4-Aminothiophenol on the Copper Corrosion Inhibition of Hybrid Sol-Gel Monolayers**, *J. Sol-Gel Sci. Technol.*, DOI: 10.1007/s10971-015-3944-5, (2016).
- [29] Karthik N., Sethuraman M.G., **Improved Copper Corrosion Resistance of Epoxy-Functionalized Hybrid Sol-Gel Monolayers by Thiosemicarbazide**, *Ionics*, **21**: 1477- 1488 (2015)
- [30] Alvarez D., Colazzo A., Hernandez M., Nova X.R., Perez C., **Characterization of Hybrid Sol-Gel Coatings Doped with Hydrotalcite-Like Compounds to Improve Corrosion Resistance of AA2024-T3 Alloys**, *Prog. Org. Coat.*, **68**: 91-99 (2010).
- [31] Krishnakumar V, Xavier R.J., **FT Raman and FT-IR Spectral Studies of 3-Mercapto-1,2,4-Triazole**, *Spectrochimica Acta Part A*, **60**: 709-714 (2004).
- [32] Lu S., Chen Y., Xu W., Liu W., **Controlled Growth of Superhydrophobic Films by Sol-Gel Method on Aluminum Substrate**, *Appl. Surf. Sci.*, **256**: 6072-6075 (2010).

- [33] Karthik N., Arunkumar V., Sethuraman M.G., Enhancement of Protection of Aluminum Through Dopamine Impregnation into Hybrid Sol-Gel Monolayers, *J. Mater. Sci.*, **49**: 7970-7978 (2014).
- [34] Lamaka S.V., Zheludkevich M.L., Yasakau K.A., Serra R., Poznyak S.K., Ferreira M.G.S., Nanoporous Titania Interlayer as Reservoir of Corrosion Inhibitors for Coatings with Self-Healing Ability, *Prog. Org. Coat.*, **58**:127-135 (2007).
- [35] Wang P, Liang C.H, Wu B, Huang N.B, Li J.L., Protection of Copper Corrosion by Modification of Dodecanethiol Self-Assembled Monolayers Prepared in Aqueous Micellar Solution, *Electrochim. Acta*, **55**: 878-883 (2010).
- [36] Ma H, Chen S, Niu L, Zhao S, Li S, Li D., Inhibition of Copper Corrosion by Several Schiff Bases in Aerated Halide Solutions, *J. Appl. Electrochem.*, **32**:65-72 (2002).
- [37] Qin T.T., Li J., Qun Luo H., Li M., Bing Li N., Corrosion Inhibition of Copper by 2, 5-Dimercapto-1, 3, 4-Thiadiazole Monolayer in Acidic Solution, *Corros. Sci.*, **53**: 1072-1078 (2011).
- [38] Zhou Y., Xu S., Guo L., Zhang S., Lu H., Gong Y., Gao F., Evaluating Two New Schiff Bases Synthesized on the Inhibition of Corrosion of Copper in NaCl Solutions, *RSC Adv.*, **5**, 14804-14813 (2015).
- [39] Appa Rao B.V, Narsihma Reddy M., Self-Assembled 1-Octadecyl-1H-Benzimidazole Film on Copper Surface for Corrosion Protection, *J. Chem. Sci.*, **125**: 1325-1338 (2013).
- [40] Appa Rao B.V., Yakub Iqbal M.d., Sreedhar B., Electrochemical and Surface Analytical Studies of the Self-Assembled Monolayer of 5-Methoxy-2-(Octadecylthio) Benzimidazole in Corrosion Protection of Copper, *Electrochim. Acta*, **55**: 620-631 (2010).
- [41] Kear G., Barker B.D., Walsh F.C., Electrochemical Corrosion of Unalloyed Copper in Chloride Media—a Critical Review, *Corros. Sci.*, **46**: 109-135 (2004).
- [42] Otmacic H., Stupnisek-Lisac E., Copper Corrosion Inhibitors in Near Neutral Media, *Electrochim. Acta*, **48**: 985-991 (2003).
- [43] Innocenzi P., Kidchob T., Hybrid Organic-Inorganic Sol-Gel Materials Based on Epoxy-Amine Systems, *J. Sol-Gel Sci. Technol.*, **35**: 225-235 (2005)