

1-Butyl-3-Methylimidazolium Bromide Promoted Selectively Oxidation of Sulfur Compounds by NaBrO_3

Shaabani, Ahmad[†]; Mofakham, Hamid; Rahmati, Abbas; Farhangi, Elham*

Department of Chemistry, Shahid Beheshti University, P.O. Box 19396-4716 Tehran, I.R. IRAN

ABSTRACT: *1-Butyl-3-methylimidazolium bromide ([bmim]Br) as an ionic liquid promoted selectively oxidation of aliphatic and aromatic sulfides to the corresponding sulfoxides and the oxidative coupling of thiols to disulfides by NaBrO_3 in excellent yields under neutral conditions.*

KEY WORDS: *1-Butyl-3-methylimidazolium bromide ([bmim]Br), Sulfides, Thiols, Disulfides.*

INTRODUCTION

Organosulfur compounds, such as sulfoxides and sulfones, are useful synthetic reagents in organic chemistry. In particular, sulfoxides are valuable synthetic intermediates for the production of a range of chemically and biologically active molecules including therapeutic agents such as antiulcer (proton pump inhibitors), antibacterial, antifungal, anti-atherosclerotic, antihypertensive and cardiotoxic agents as well as psychotropics and vasodilators [1-7]. The oxidation of sulfides and utilization of sulfoxides has been reviewed recently [8]. Many reagents are available for the oxidation of sulfides, but most of them are conventional oxidants, which are not suitable for medium to large scale synthesis.

Sodium bromate is commercially available as an inexpensive stable solid, which potentially is an interested candidate for the oxidation of organic compounds because of its capability in multielectron transfer. Although, sodium bromate is thermodynamically a strong oxidant, but according to the literature bromate itself is not able to oxidize organic compounds [9]. Standard redox potential of the bromate ion, BrO_3^- , is 0.61 V in neutral and alkaline aqueous solution while in aqueous acidic media it has a potential of 1.52 V. Due to low

standard redox potential in neutral or weak acidic media and very low solubility in most of organic solutions, it is usually used in aqueous media in the presence of strong acidic co-reactants such as: NaHSO_3 [10], HBr [11], cerium (IV) ammonium nitrate (CAN) [12], H_2SO_4 [13], KHSO_4 [14], Bu_4NHSO_4 [15], HClO_4 [16], $\text{Mg}(\text{HSO}_4)_2$ [17], silica sulfuric acid [18] and cation exchange resin and ruthenium complexes [19].

In spite of their potential utility and solubility in these media, most of the homogeneous acids present limitations due to use of corrosive reagents, the tedious work-up procedure, the necessity of neutralization of strong acidic media, is producing undesired washes. In addition, high acidity of solution not only increased the oxidizing powerful of BrO_3^- and restricted to apply this reagent for the selective oxidation of most of organic compounds, but due to bromine generation under acidic conditions in the presence of reducing agents [20-21] the main product becomes contaminated by the formation of bromo substituted of sulfides and sulfoxides. So, due to bromine generation we have to neutralize the reaction mixture with sodium thiosulfate before separating of product. Furthermore, in most of these oxidation systems

* To whom correspondence should be addressed.

+ E-mail: a-shaabani@cc.sbu.ac.ir

1021-9986/12/1/1

7/5/2.70

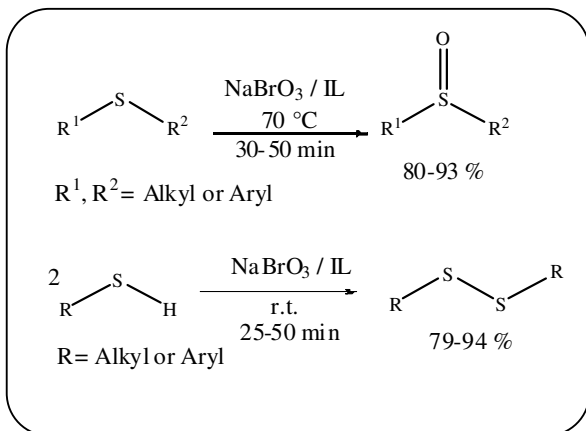

Scheme 1

the removal of excess sodium bromate from reaction mixture and separation of bromate or bromide from co-reactant salts is difficult.

Therefore, the discovery of new approaches for the selective oxidation of sulfur compounds by NaBrO_3 , in which there is no need to use acidic co-reactants is of some importance in synthetic organic compounds. One can wonder whether inert Ionic Liquids (ILs) are useful solvents for NaBrO_3 mediated organic transformations, taking into account the popularity of ionic liquids as alternative solvents for organic reactions [22-29]. To the best of our knowledge, ILs has not been explored for reactions with NaBrO_3 yet.

In continuation of our studies on the oxidation of organic compounds [20, 30-34], in this paper we evaluate various ionic liquids for BrO_3^- mediated the oxidation of aliphatic and aromatic sulfides and thiols under neutral conditions in non-aqueous media (Scheme 1).

EXPERIMENTAL SECTION

Melting points were measured on an Electrothermal 9100 apparatus and are uncorrected. Mass spectra were recorded on a Shimadzu GCMS-QP1100EX mass spectrometer operating at an ionization potential of 70 eV. IR spectra were recorded on a Shimadzu IR-470 spectrometer. ^1H and ^{13}C NMR spectra were recorded on a BRUKER DRX-300 AVANCE spectrometer at 300.13 and 75.47 MHz. NMR spectra were obtained on solution in $\text{DMSO}-d_6$ using TMS as internal standard. The chemicals used in this work were purchased from Merck and Fluka Chemical Companies.

General procedure for oxidation of sulfide using NaBrO_3 and $[\text{bmim}]\text{Br}$

The oxidant (NaBrO_3 , 0.5 g, 3.3 mmol) was placed in a round-bottom flask and added the sulfide (1.0 mmol) and $[\text{bmim}]\text{Br}$ (0.3 g). The reaction mixture was stirred continuously at 70°C using a magnetically controlled stirring bar; TLC was used to monitor the progress of the reactions until the sulfide completely reacted or until a reasonable amount of time had elapsed. Upon completion, the reaction mixture was washed with EtOAc or CH_2Cl_2 (20 mL). Evaporation of the solvent gave a product of sufficient purity for most purposes.

General procedure for oxidation of thiol using NaBrO_3 and $[\text{bmim}]\text{Br}$

The oxidant (NaBrO_3 , 0.5 g, 3.3 mmol) was placed in a round-bottom flask and added the thiol (1.0 mmol) and $[\text{bmim}]\text{Br}$ (0.3 g). The reaction mixture was stirred continuously at room temperature using a magnetically controlled stirring bar; TLC was used to monitor the progress of the reactions until the thiol completely reacted or until a reasonable amount of time had elapsed. Upon completion, the disulfide is isolated by washing the reaction mixture with water.

RESULTS AND DISCUSSION

In order to select the best ionic liquid, various ionic liquids we examined, such as 1-butyl-3-methylimidazolium bromide ($[\text{bmim}]\text{Br}$), 1-butyl-3-methylimidazolium chloride ($[\text{bmim}]\text{Cl}$) and tetramethylguanidinium trifluoroacetate (TMGT) in acidic [molar ratio of tetramethylguanidine (TMG):trifluoroacetic acid (TFA) or TMG:TFA 1:1.5], basic (molar ratio of TMG:TFA 1.5:1) and neutral (molar ratio of TMG:TFA 1:1) conditions. Oxidation of benzyl phenyl sulfide to benzyl phenyl sulfoxide and oxidative coupling of 2-naphtalene thiol to 2-naphtalene disulfide were selected as model reactions. Test reactions were carried out by mixing NaBrO_3 (0.5 g, 3.3 mmol) with various ILs (0.3 g) followed by addition of benzyl phenyl sulfide (0.2 g, 1mmol) or 2-naphtalene thiol (0.16g, 1mmol). As indicated in Table 1, the most of these ionic liquids are not effective oxidants for this transformation under the mentioned conditions, and $[\text{bmim}]\text{Br}$ is the best oxidant under these conditions.

Table 1: Oxidation of benzyl phenyl sulfide and oxidative coupling of 2-naphthalene thiol in the various Ionic Liquids.

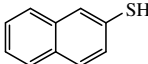
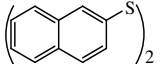
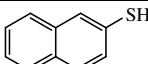
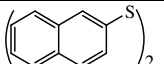
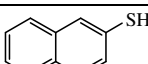
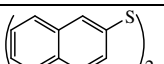
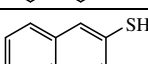
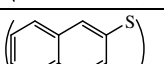
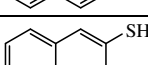
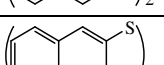
Entry	Substrate	Product	Ionic Liquid	Time (min)	Yield ^a (%)
1	PhCH ₂ SPh	PhCH ₂ SOPh	[bmim]Br	45	91
2	PhCH ₂ SPh	PhCH ₂ SOPh	[bmim]Cl	45	-
3	PhCH ₂ SPh	PhCH ₂ SOPh	TMG:TFA 1:1.5	45	-
4	PhCH ₂ SPh	PhCH ₂ SOPh	TMG:TFA 1.5:1	45	-
5	PhCH ₂ SPh	PhCH ₂ SOPh	TMG:TFA 1:1	45	-
6			[bmim]Br	25	90
7			[bmim]Cl	25	-
8			TMG:TFA 1:1.5	25	-
9			TMG:TFA 1.5:1	25	-
10			TMG:TFA 1:1	25	-

a) Reaction conditions: NaBrO₃ (0.5 g, 3.3 mmol) with various ILs (0.3 g) followed by addition of benzyl phenyl sulfide (0.2 g, 1mmol) or 2-naphthalene thiol (0.16 g, 1mmol).



As shown in Table 2, using this oxidation system, a wide variety of alkyl aryl and dialkyl sulfides was oxygenated to their corresponding sulfoxides in high yields within less than 1 hour. The sulfoxides are isolated by washing the reaction mixture with appropriate (EtOAc or CH₂Cl₂) solvent. Evaporation of solvent under vacuum produces pure sulfoxide without any purification. All the reactions occurred with complete selectivity for sulfoxide formation, no overoxidation products such as sulfones or bromo derivatives sulfoxide were detected in the reaction mixtures. This method offers a simple, general, fast, selective and highly efficient approach for converting sulfides to the corresponding sulfoxides under the neutral conditions. Observation of oxidation benzyl phenyl sulfide and dibenzyl sulfide to the corresponding sulfoxide (Entries 9 and 10 Table 2) indicates that the reaction proceeds by way of an oxygen transfer mechanism. If the reaction involved electron transfer instead of oxygen transfer, substantial amounts of benzaldehyde would have been formed [35-36].

We have compared the results of our investigations with reported reagents such as BuNIO₄/AlCl₃ [37], Ba(MnO₄)₂ [38], Bi(NO₃)₃.5H₂O/HOAc [39], H₂O₂ [40], CuBr₂ [41] and TBAP/AlCl₃ [42] (Table 3). The results show that NaBrO₃/[bmim]Br is a best oxidant system reagent in times and yields.

The presented oxidation coupling of thiols by NaBrO₃/[bmim]Br is a convenient alternative to the reported reagents in terms of the reaction times, the yields of the disulfides, mild reaction conditions and no necessary use acidic media. In addition to the greater safety in handling and ease use of NaBrO₃/[bmim]Br, the product can be isolated by simple washing and filtration with water. To demonstrate the utility of the procedure described here, a 10 fold scale oxidation was carried out with NaBrO₃/[bmim]Br for the oxidative coupling of 4-chlorothiophenole and the corresponding disulfide was obtained in 85% yield within 40 min.

One of the advantages of ionic liquids is their ability to function as a recyclable reaction medium. The IL was

Table 2: Oxidation of sulfides to sulfoxides and oxidative coupling of thiols to disulfides by NaBrO₃/[bmim]Br.

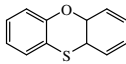
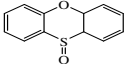
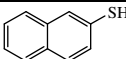
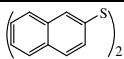
Entry	Substrate	Product	Time (min)	Yield ^a (%)	M. p. or B.p.(°C) Found	M.p. or B.p.(°C) Reported ^{ref.}
1	(CH ₃ CH ₂) ₂ S	(CH ₃ CH ₂) ₂ SO	35	88	102-104	103-106 ⁴³
2	[CH ₃ (CH ₂) ₂] ₂ S	(CH ₃ (CH ₂) ₂) ₂ SO	35	81	23-25	24.5-25.5 ⁴⁴
3	[CH ₃ (CH ₂) ₃] ₂ S	(CH ₃ (CH ₂) ₃) ₂ SO	40	80	27-30	29-31.6 ⁴⁴
4			35	83	233-234	235-237 ⁴⁴
5	PhSCH ₃	PhSOCH ₃	30	91	32-34	33-34 ⁴⁵
6	PhSCH ₂ CH ₃	PhSOCH ₂ CH ₃	40	89	143-145	146 ⁴⁴
7	<i>p</i> -O ₂ NC ₆ H ₄ SCH ₃	<i>p</i> -O ₂ NC ₆ H ₄ SOCH ₃	45	93	139-141	140-142 ⁴⁴
8	PhSPh	PhSOPh	50	92	67-69	70.5 ⁴⁶
9	PhCH ₂ SPh	PhCH ₂ SOPh	45	90,91,88 ^b	121-123	123-124 ⁴⁵
10	PhCH ₂ SCH ₂ Ph	PhCH ₂ SOCH ₂ Ph	40	88	130-131	133-135 ⁴⁵
11			45	91	151-154	153-155 ⁴⁷
12	PhSOPh	No reaction	20 (hr)	-	-	-
13	CH ₃ (CH ₂) ₂ SH	(CH ₃ (CH ₂) ₂ S) ₂	30	79	189-191	193 ⁴⁸
14	CH ₃ (CH ₂) ₃ SH	(CH ₃ (CH ₂) ₃ S) ₂	35	83	187-190	192 ⁴⁸
15	CH ₃ (CH ₂) ₄ SH	(CH ₃ (CH ₂) ₄ S) ₂	35	91	127-129	128-130 ⁴⁹
16	CH ₃ (CH ₂) ₇ SH	(CH ₃ (CH ₂) ₇ S) ₂	40	90	72-74	74-75 ⁴⁵
17	C ₆ H ₁₁ SH	(C ₆ H ₁₁ S) ₂	50	86	121-123	125-130 ⁴⁶
18	PhSH	(PhS) ₂	45	91	59-61	61-62 ⁴⁶
19	<i>p</i> -ClC ₆ H ₄ SH	(<i>p</i> -ClC ₆ H ₄ S) ₂	40	93	72-73	73-74 ⁵⁰
20	<i>p</i> -CH ₃ C ₆ H ₄ SH	(<i>p</i> -CH ₃ C ₆ H ₄ S) ₂	40	89	42-44	45-46 ⁴⁹
21	PhCH ₂ SH	(PhCH ₂ S) ₂	45	94	67-69	69-72 ⁴⁶
22			25	90	137-139	139 ⁵¹

^a isolated yields. ^b the same ionic liquid was used for each of the three runs

Table 3: Comparison of the results of NaBrO₃/[bmim]Br with those obtained from BuNIO₄/AlCl₃ (1) [37], Ba(MnO₄)₂ (2) [38], Bi(NO₃)₃. 5H₂O/HOAc (3) [39], H₂O₂ (1) [40], CuBr₂ (2) [41] and TBAP/AlCl₃ (3) [42].

Entry	Substrate	Product	Yield % (min)	Yield % (h) reported by other methods					
			NaBrO ₃ /[bmim]Br	1	2	3	4	5	6
1	PhSCH ₃	PhSOCH ₃	91 (30)	70 (4)	-	-	82 (1.5)	-	70
2	PhCH ₂ SCH ₂ Ph	PhCH ₂ SOCH ₂ Ph	88 (40)	-	-	85 (4)	88 (4)	-	75
3	[CH ₃ (CH ₂) ₃] ₂ S	(CH ₃ (CH ₂) ₃) ₂ SO	80 (40)	75 (4)	77 (4)	68 (2)	92 (2)	89 (2.25)	-

Table 4: Oxidation of benzyl phenyl sulfide with NaBrO₃ in the presence of NH₄Cl, NH₄Br, KBr and various ionic liquids.

Entry	Substrate	Product	Catalyst	Time (min)	Yield ^a %
1	PhCH ₂ SPh	PhCH ₂ SOPh	NH ₄ Cl	45	85
2	PhCH ₂ SPh	PhCH ₂ SOPh	NH ₄ Br	45	87
3	PhCH ₂ SPh	PhCH ₂ SOPh	KBr	45	70
4	PhCH ₂ SPh	PhCH ₂ SOPh	TMG:TFA	45	0
5	PhCH ₂ SPh	PhCH ₂ SOPh	[bmim]F	45	0
6	PhCH ₂ SPh	PhCH ₂ SOPh	[bmim]I	45	87
7	PhCH ₂ SPh	PhCH ₂ SOPh	[bmim]PF ₆	45	14
8	PhCH ₂ SPh	PhCH ₂ SOPh	[bmim]Cl	45	0
9	PhCH ₂ SPh	PhCH ₂ SOPh	[bmim]Br	45	91

a) Reaction conditions: NaBrO₃ (0.5 g, 3.3 mmol) with in the presence of NH₄Cl, NH₄Br, KBr, TMG:TFA and ionic liquids (0.3 g) followed by addition of benzyl phenyl sulfide (0.2 g, 1mmol).

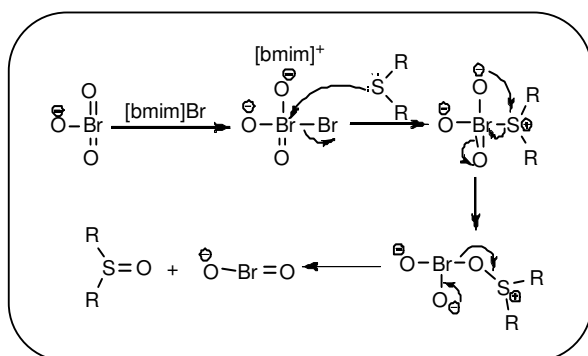
**Scheme 2**

separated from the reaction medium easily by washing with cold water and evaporating the solvent under vacuum, and reuses it for subsequent reactions (Table 2, Entry 9).

The mechanism was proposed as depicted in Scheme 2. The oxidation may involve the initial polarization of the Br=O bond by [bmim]Br then a nucleophilic attack of sulfur on the hypervalent bromine (V) center followed by a concerted oxygen transfer to give sulfoxides. Over-oxidation to sulfones does not occur and this could be attributed to the low nucleophilicity of sulfoxide (Table 2, Entry 12 and Scheme 2) [14].

For clarifying the proposed mechanism, we have also investigated the oxidation reaction in the presence of NH₄Cl, NH₄Br, KBr and ionic liquids such as [bmim]Cl, [bmim]I and [bmim]PF₆. As, indicated in Table 4,

the reaction proceed efficient in the presence of NH₄Cl, NH₄Br, KBr and [bmim]I in which supported the proposed mechanism.

CONCLUSIONS

In summary, we have developed an efficient and fast procedure for selectively oxidation of sulfide to sulfoxide and oxidative coupling of thiols to disulfide using BrO₃⁻ mediated with [bmim]Br as an ionic liquid. This method possesses increased compatibility to different functional group and the oxidation reaction is carried out in neutral conditions and unlike previously reported methods, this one requires neither an acids as co-oxidant nor protic solvents such as water. Further application of these reagents combination is under investigation in our novel neutral media system derived from BrO₃⁻ mediated with IL for the oxidation of other organic compounds.

Acknowledgments

We gratefully acknowledge the financial support from the Research Council of Shahid Beheshti University.

Received : Jan. 20, 2010 ; Accepted : May 2, 2011

REFERENCES

- [1] Prilezhaeva E.N., Rearrangements of Sulfoxides and Sulfones in the Total Synthesis of Natural Compounds, *Russ. Chem. Rev.*, **70**, p. 897 (2001).
- [2] Carreno M.C., Applications of Sulfoxides to Asymmetric Synthesis of Biologically Active Compounds, *Chem. Rev.*, **95**, p. 1717 (1995).
- [3] Fernandez I., Khair N., Recent Developments in the Synthesis and Utilization of Chiral Sulfoxides, *Chem. Rev.*, **103**, p. 3651 (2003).
- [4] Thorarensen A., Palmgren A., Itami K., Backvall J.E., Palladium(II)-Catalyzed Asymmetric 1,4-Oxidation of 2-Phenyl-1,3-Cyclohexadiene, *Tetrahedron Lett.*, **38**, p. 8541 (1997).
- [5] Padmanabhan S., Lavin R.C., Durant G.J., Asymmetric Synthesis of a Neuroprotective and Orally Active N-Methyl-d-Aspartate Receptor Ion-Channel Blocker, CNS 5788, *Tetrahedron: Asymm.*, **11**, p. 3455 (2000).
- [6] Rowlands J.G., Chiral Sulfoxide Ligands in Catalytic Asymmetric Cyanohydrin Synthesis, *Synlett*, **236** (2003).
- [7] Dorta R., Shimon L.J.W., Milstein D., Dimethylsulfoxide as a Ligand for RhI and IrI Complexes-Isolation, Structure and Reactivity Towards X=H Bonds (X=H, OH, OCH₃), *Chem. Eur. J.*, **9**, p. 5237 (2003).
- [8] (a) Khenkin A.M., Neumann R., Oxygen Transfer from Sulfoxides: Oxidation of Alkylarenes Catalyzed by A Polyoxomolybdate, [Pm₁₂O₄₀]³⁻, *J. Am. Chem. Soc.*, **124**, p. 4198 (2002).
- (b) Kaczorowska K., Kolarska Z., Mitka K., Kowalski P., Oxidation of Sulfides to Sulfoxides, Part 2: Oxidation by Hydrogen Peroxide, *Tetrahedron*, **61**, p. 8315 (2005).
- [9] Olah G.A., Gupta B.G.B., Fung A.P., Synthetic Methods and Reactions; 95¹. Ceric Ammonium Nitrate-Catalyzed Oxidative Cleavage of Alkyl and Silyl Ethers with Sodium Bromate, *Synthesis*, **897** (1980).
- [10] (a) Kikuchi D., Sakaguchi S., Ishii Y., An Alternative Method for the Selective Bromination of Alkylbenzenes Using NaBrO₃ / NaHSO₃ Reagent, *J. Org. Chem.*, **63**, p. 6023 (1998).
- (b) Biernstiel M., Dhondt P.J., Schalaf M., Investigation Into the Selective Oxidation of Vicinal Diols to α -Hydroxy Ketones with the NaBrO₃ / NaHSO₃ Reagent: pH Dependence, Stoichiometry, Substrates and Origin of Selectivity, *Tetrahedron*, **61**, p. 4911 (2005).
- (c) Takes K., Masuda O., Kaf O., Nishiyama Y., Oxidative Esterification of Primary Alcohols by NaBrO₃ / NaHSO₃ Reagent in Aqueous Medium, Sakguchi S., Ishii Y., *Chem. Lett.*, 871 (1995).
- (d) Sakguchi S., Kikuchi D., Ishii Y., Oxidation of Diols and Ethers by NaBrO₃ / NaHSO₃ Reagent, *Bull. Chem. Soc. Jpn.*, **70**, p. 2561 (1997).
- [11] Kajigaeshi S., Nakagawa T., Nakasaki N., Yamasaki H., Fujisaki S., Oxidation of Alcohols and Ethers Using Sodium Bromate-Hydrobromic Acid System, *Bull. Chem. Soc. Jpn.*, **59**, p. 747 (1986).
- [12] (a) Ho T.L., Cerium(IV)-Oxidation with a Dual Oxidant System; Reaction of Some Arylamethanols, *Synthesis*, **936** (1978).
- (b) Tomioka H.O., Nozaki K.H., Cerium Catalyzed Selective Oxidation of Secondary Alcohols in the Presence of Primary Ones, *Tetrahedron Lett.*, **23**, p. 539 (1982).
- (c) Hajipour A.R., Khazdooz L., Ruoho A.E., Selective and Efficient Oxidation of Sulfides to Sulfoxides Using Ceric Ammonium Nitrate (CAN)/Bronsted Acidic Ionic Liquid, *Phosphorus, Sulfur, and Silicon*, **178**, p. 705 (2009).
- [13] (a) Wang Y., Zhao Y., Wang X., Duan Z., Synthesis of New-Typed α,β -Unsaturated Acyl Azo Compounds with NaBrO₃/H₂SO₄ as the Oxidative System, *Synth. Commun.*, **32**, p. 1781 (2002).
- (b) Hoist G., The Oxidation of Thioglycol by Iodate or Bromated Ions in Solutions of Sulfuric Acid, *Kgl. Fysiograf. Sallskap. Lund*, **10**, p. 63 (1940) (*Chem. Abst.* 1941, 35, 78089).
- [14] Metsger L., Bittner S., Autocatalytic Oxidation of Ethers with Sodium Bromate, *Tetrahedron*, **56**, p. 1905 (2000).
- [15] Shaabani A., Bazgir A., Teimouri M.B., Conversion of Alkylbenzenes to Carbonyl Compounds by NaBrO₃ in the Presence of NH₄Cl and Bu₄NHSO₄, *Synth. Commun.*, **32**, p. 675 (2002).
- [16] Chatterji A. C., Roy S.K.Z., Mechanism of Oxidation of Simple Organic Molecules (XXIV) Oxidation of Methyl, Ethyl, Propyl, and Isopropyl Alcohols by Bromate Ion in Acid Media, *Phys. Chem.*, **250**, p. 137 (1972) (*Chem. Abst.* 1972, 77, 39201z).
- [17] (a) Shaabani A., Bazgir A., Soleimani K., Salehi P., Solvent Effects in the Oxidation of Sulfides with NaBrO₃/Mg(HSO₄)₂, *Synth. Commun.*, **33**, p. 2935 (2003).

- [18] Shaabani A., Soleimani K., Bazgir A., Silica Sulfuric Acid Catalysis the Oxidation of Organic Compounds with Sodium Bromate, *Synth. Commun.*, **34**, p. 3303 (2004).
- [19] (a) Dykeman R.R., Luska K.L., Thibault M.E., Jones M.D., Schlaf M., Khanfar M., Taylor N.J., Britten J.F., Harrington L., Catalytic Deoxygenation of Terminal-Diols Under Acidic Aqueous Conditions by the Ruthenium Complexes $[(\eta^6\text{-Arene})\text{Ru}(\text{X})(\text{N} \cap \text{N})](\text{OTf})_n$, $\text{X} = \text{H}_2\text{O}$, H , $\eta^6\text{-Arene} = p\text{-Me-}^i\text{Pr-C}_6\text{H}_4$, C_6Me_6 , $\text{N} \cap \text{N} = \text{Bipy}$, Phen , $6,6'$ -Diamino-Bipy, $2,9$ -Diamino-Phen, $n = 1, 2$): Influence of the Ortho-Amine Substituents on Catalytic Activity, *J. Mol. Cat. A*, **277**, p. 233 (2007).
- (b) Shaabani A., Lee D.G., Selective Oxidation of Sulfides Under Solvent-Free Conditions, *Sulfur Lett.*, **26**, p. 43 (2003).
- [20] (a) Shaabani A., Ameri M., Oxidation of Benzylic and Secondary Alcohols to Carbonyl Compounds by $\text{NaBrO}_3\text{-NH}_4\text{Cl}$ Reagent in Aqueous Acetonitrile, *J. Chem. Research(S)*, **100** (1998).
- (b) Shaabani A., Teimouri M.B., Safaei H.R., A Simple and Efficient Procedure for Oxidation of Sulfides to Sulfoxides by Hexamethylenetetramine-Bromine Complex(HMTAB), *Synth. Commun.*, **30**, p. 265 (2000).
- (c) Shaabani A., Karimi A.R., Oxidation Deprotection of Trimethylsilyl Ethers to Carbonyl Compounds by $\text{NaBrO}_3\text{-NH}_4\text{Cl}$ Reagent in Aqueous Acetonitrile, *Synth. Commun.*, **31**, p. 759 (2001).
- [21] Kikuchi D., Sakaguchi S., Ishii Y., An Alternative Method for the Selective Bromination of Alkylbenzenes Using $\text{NaBrO}_3/\text{NaHSO}_3$ Reagent, *J. Org. Chem.*, **63**, p. 6023 (1998).
- [22] Earle M.J., Seddon K.R., Ionic Liquids. Green Solvents for the Future, *Pure Appl. Chem.*, **72**, p. 1391 (2000).
- [23] Welton T., Room-Temperature Ionic Liquids. Solvents for Synthesis and Catalysis, *Chem. Rev.*, **99**, p. 2071 (1999).
- [24] Wasserscheid P., Keim W., Ionic Liquids-New "Solutions" for Transition Metal Catalysis, *Angew. Chem. Int. Ed.*, **39**, p. 3773 (2000).
- [25] Dupont J., de Souza R.F., Suarez P.A.Z., Ionic Liquid (Molten Salt) Phase Organometallic Catalysis, *Chem. Rev.*, **102**, p. 3667 (2002).
- [26] Sheldon R., Catalytic Reactions in Ionic Liquids, *Chem. Commun.*, **2399** (2001).
- [27] Wasserscheid P., Welton T., "Ionic Liquids in Synthesis", Wiley-VCH: Weinheim (2002).
- [28] Gordon C.M., New Developments in Catalysis Using Ionic Oiquids, *Appl. Catal. A*, **222**, p. 101 (2001).
- [29] Muzart J., Ionic Liquids as Solvents for Catalyzed Oxidations of Organic Compounds, *Adv. Synth. Catal.*, **348**, p. 275 (2006).
- [30] Shaabani A., Bazgir A., Abdoli M., A New and Efficient Aerobic Oxidation of Aldehydes to Carboxylic Acids with Singlet Oxygen in the Presence of Porphyrin Sensitizers and Visible Light, *Synth. Commun.*, **32**, p. 683 (2002).
- [31] Shaabani A., Bazgir A., Teimouri F., Lee D.G., Selective Oxidation of Alkylarenes in Dry Media with Potassium Permanganate Supported on Montmorillonite K10, *Tetrahedron Lett.*, **43**, p. 5165 (2002).
- [32] Shaabani A., Lee D.G., Solvent Free Permanganate Oxidations, *Tetrahedron Lett.*, **42**, p. 5833 (2001).
- [33] Shaabani A., Mirzaei P., Naderi S., Lee D.G., Green Oxidations. The Use of Potassium Permanganate Supported on Manganese Dioxide, *Tetrahedron*, **60**, p. 11415 (2004).
- [34] Shaabani A., Safaei H.R., Bazgir A., Oxidation of Sulfides to Sulfoxides by $\text{NaBrO}_3\text{-NH}_4\text{Cl}$ in Aqueous Acetonitrile, *Iran. J. Chem. Chem. Eng.*, **19**, p. 47 (2000).
- [35] Baciocchi E., Lanzalunga O., Malandrucchio S., Oxidation of Sulfides by Peroxidases. Involvement of Radical Cations and the Rate of the Oxygen Rebound Step, *J. Am. Chem. Soc.*, **118**, p. 8973 (1996).
- [36] Baciocchi E., Lanzalunga O., Pirozzi B., Oxidations of Benzyl and Phenethyl Phenyl Sulfides. Implications for the Mechanism of the Microsomal and Biomimetic Oxidation of Sulfides, *Tetrahedron*, **53**, p. 12287 (1997).
- [37] Firouzabadi H., Sardarian A., Badparva H., Oxidation of Organic Compounds with Tetrabutylammonium Periodate in the Presence of Lewis Acids in Aprotic Organic Solvents, *Bull. Chem. Soc. Jpn.*, **69**, p. 685 (1996).
- [38] Firouzabadi H., Seddighi M., Conversion of Sulfides to Their Corresponding Sulfoxides with Barium Permanganate $\text{Ba}(\text{MnO}_4)_2$ Under Non-Aqueous Conditions, *Synth. Commun.*, **21**, p. 211 (1991).

- [39] Mashraqui S.H., Mudaliar C.D., Karnik M.A., $\text{Bi}(\text{NO}_3)_3 \cdot 5\text{H}_2\text{O}$: A Convenient Reagent for Selective Oxidation of Sulfides to Sulfoxides, *Synth. Commun.*, **28**, p. 939 (1998).
- [40] Karimi B., Ghoreishi-Nezhad M., Clark J.H., Selective Oxidation of Sulfides to Sulfoxides Using 30% Hydrogen Peroxide Catalyzed with a Recoverable Silica-Based Tungstate Interphase Catalyst, *Org. Lett.*, **7**, p. 625 (2005).
- [41] Das R., Chakraborty D., Cu(II)-Catalyzed Oxidation of Sulfides, *Tetrahedron Lett.*, **51**, p. 6255 (2010).
- [42] Firouzabadi H., Sardarian A., Badparva H., Oxidation of Organic Compounds with Tetrabutylammonium Periodate in the Presence of Lewis Acids in Aprotic organic Solvents, *Bull. Chem. Soc. Jpn.*, **69**, 685 (1996).
- [43] "Handbook of Chemistry and Physics", 70th Ed., CRC Press, (1989-1990).
- [44] Searles S.J., Hays H.Y., Notes - Oxidation of Organic Sulfides with Dimethyl Sulfoxide, *J. Org. Chem.*, **23**, p. 2028 (1958).
- [45] "Dictionary of Organic Compounds", 6th Ed., Chapman and Hall, London, (1966).
- [46] Orito K., Hatakeyama T., Takeo M., Suginoma H., Oxidation with Mercury(II) Oxide-Iodine Reagent: Selective Oxidation of Sulfides to Sulfoxides, *Synthesis*, **1357** (1995).
- [47] Ho T.-L., Wong C.M., Dethioacetalization via S-Methylation, *Synthesis*, **561** (1972).
- [48] Iranpoor N., Firouzabadi H., Zolfigol M.A., Dinitrogen Tetroxide Copper Nitrate Complex $[\text{Cu}(\text{NO}_3)_2 \cdot \text{N}_2\text{O}_4]$ as a New Nitrosating Agent for Catalytic Coupling of Thiols via Thionitrite, *Synth. Commun.*, **28**, p. 367 (1998).
- [49] Lide D.R.; "CRC Handbook of Chemistry and Physics", 74th Ed., CRC Press, Ann Arbor, (1993).
- [50] "The Sadtler Standard Spectra, NMR", Sadtler Research Laboratories, INC, 12327M, (1972). CA, 52, 4543 (1958).
- [51] Wallace T.J., Reactions of Thiols with Sulfoxides. I. Scope of the Reaction and Synthetic Applications, *J. Am. Chem. Soc.*, **86**, p. 2018 (1964).