

New Strategy for the Synthesis of Morpholine Cores: Synthesis from *N*-Propargylamines

Vessally, Esmail

Department of Chemistry, Payame Noor University, Tehran, I.R. IRAN

Hosseiniyan, Akram

*Department of Engineering Science, College of Engineering, University of Tehran,
P.O. Box 11365-4563 Tehran, I.R. IRAN*

Edjlali, Ladan*[†]; Babazadeh, Mirzaagha; Hosseinzadeh-Khanmiri, Rahim

Department of Chemistry, Tabriz Branch, Islamic Azad University, Tabriz, I.R. IRAN

ABSTRACT: Functionalized morpholines have attracted much attention due to their potential biological activities. Despite wide importance of morpholine derivatives in drug design of various pharmacological agents, the development of new approaches to their synthesis remains relatively unexplored. Given the low cost and easy availability of *N*-propargylamines, the synthesis of functionalized morpholines from these versatile building blocks have undergone an explosive growth in recent years. This review provides concise overview on the synthesis of morpholine cores from *N*-propargylamines in recent years.

KEYWORDS: *N*-propargylamines, Morpholines; 6-*exo-dig* cyclization; Cyclo-ketalization; Bridged systems.

INTRODUCTION

Heterocyclic compounds are not only prevalent in an extensive number of natural products and synthetic pharmaceuticals but also used as building blocks in organic synthesis [1]. Morpholine is one of the most important heterocyclic compound having the chemical formula $O(CH_2CH_2)_2NH$. This heterocycle belongs to a featured scaffold embedded in naturally occurring alkaloids such as chelonin, Monanchocidin, and acortatarins. [2] This heterocycle continues to play an overwhelming role in the development of new human medicines. Several of the drugs sold today are substituted

morpholines or contain a morpholine ring as a key component. For examples, Linezolid **1** with brand name of Zyvox, is an antibiotic drug marketed worldwide for the treatment of infections of the skin and blood. [3] Finafloxacin **2** is used for treating acute otitis externa (swimmer's ear). [4] Aprepitant **3** is used to prevent nausea and vomiting after surgery. It works by blocking the neurokinin 1 (NK1) receptor. [5] Reboxetine **4** with brand name of Edronax, is an antidepressant drug used in the treatment of clinical depression and panic disorder. [6] Emorfazone **5** is a nonacidic and nonsteroidal

* To whom correspondence should be addressed.

+ E-mail: l_edjlali@iaut.ac.ir

1021-9986/2017/3/1-13

13/\$/6.30

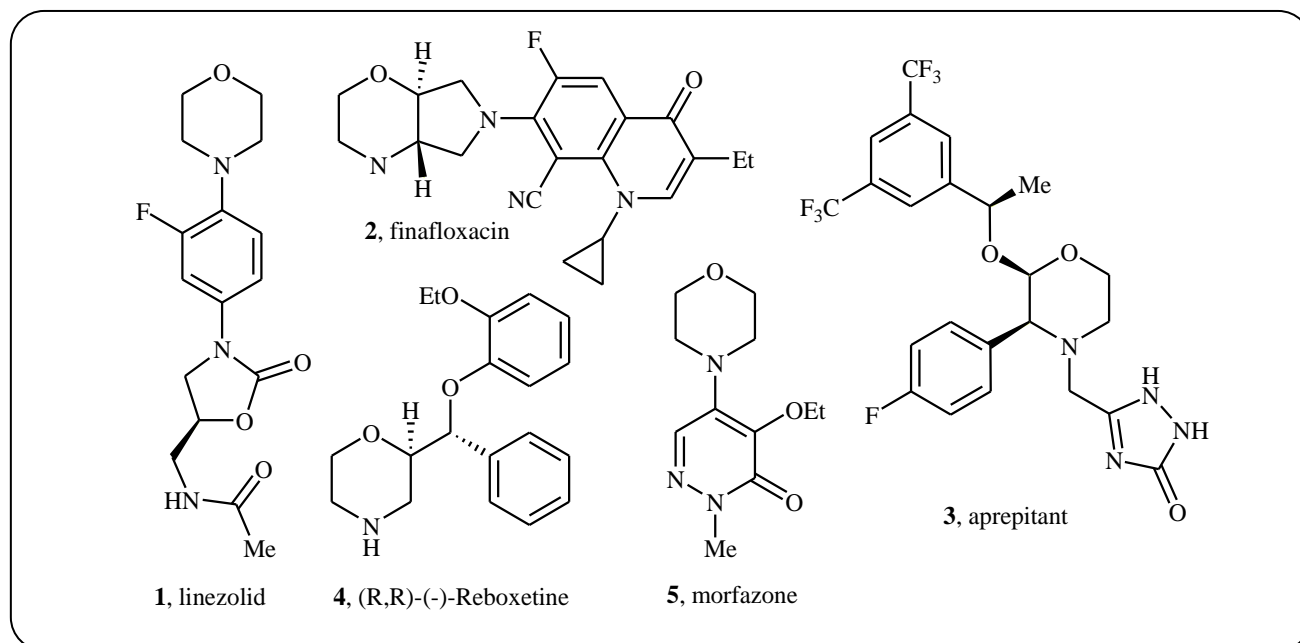

Fig. 1: Selected examples of drugs containing morpholine core.

anti-inflammatory drug available in a number of countries worldwide. [7] However, despite the medicinal importance of morpholine cores, the development of new approaches toward their efficient synthesis remains relatively unexplored. [8]

N-Propargylamines are a special class of alkynes extensively applied as precursors in the preparation of many nitrogen heterocyclics such as pyrrole, [9, 15] pyridine, [10, 15] pyrazine, [11], quinoline, [12] imidazole, [13] 1,4-oxazepane, [14] 1,4-diazepanes, [14, 15] thiazoles [16]. They have also been utilized as intermediates in the total synthesis of some complex natural products. [17] In this regard, the synthesis of functionalized morpholines from these versatile building blocks have undergone an explosive growth in recent years. This new strategy to synthesis of morpholine derivatives has successfully overcome most of the disadvantages (*e.g.* harsh reaction conditions, poor selectivity, poor atom economy, and limited structural features of starting materials) associated with conventional methodologies. To the best of our knowledge, a comprehensive review has not appeared on synthesis of morpholines from *N*-propargylamines in literature. In this Focus Review, we have classified these reactions based on the desired products (highly substituted, fused, and bridged morpholines). Mechanistic aspects of the reactions are considered and discussed in detail.

HIGHLY SUBSTITUTED MORPHOLINES

First applications of *N*-propargylamines for construction of morpholine cores dates back to the early 1980s. In 1982, Yamamoto *et al.* described the synthesis of some 6-methylenemorpholin-2-ones **7** in 12-36% yield with a mixture of 3,4-dihydro-1,4-oxazin-2-ones **8** by the Hg-catalyzed heterocyclization of *N*-protected *N*-propargylamino acids **6** (Table 1). Among the various solvents like DMF, HMPA, THF, benzene, chloroform, acetone; toluene was the most efficient for this transformation. The authors claimed their reaction was the first general strategy for the synthesis of such heterocycles. The results demonstrated that *N*-unsubstituted substrates failed to participate in this reaction and in order to examine the stereochemistry of the products, the obtained compounds showed low to zero optical rotation. [18]

Along this line, the group of *T. E. Long* has recently described a novel approach to the asymmetrical synthesis of (*E*)-6-(halomethylene)morpholin-2-ones **10** via electrophilic cyclization reaction of chiral *N,N*-propargyl α -amino esters **9** (Scheme 1). The cyclization products showed a growth inhibitory activity against the prostate cancer cells. However, the results were unsatisfactory in terms of yield. [19]

In 2007, the group of *M. Shi* were able to demonstrate that a series of 2,6-*trans*-substituted morpholines **12**

Table 1: Hg-catalyzed heterocyclization of *N*-protected *N*-propargylamino acids **6 developed by Yamamoto.**

Entry	R ¹	R ²	Yield (%)	7:8
1	^t Bu	Ac	71	44:56
2	^t Bu	Bz	74	47:53
3	Bn	Ac	59	41:59
4	Bn	Bz	44	27:73
5	H	Bz	63	57:43

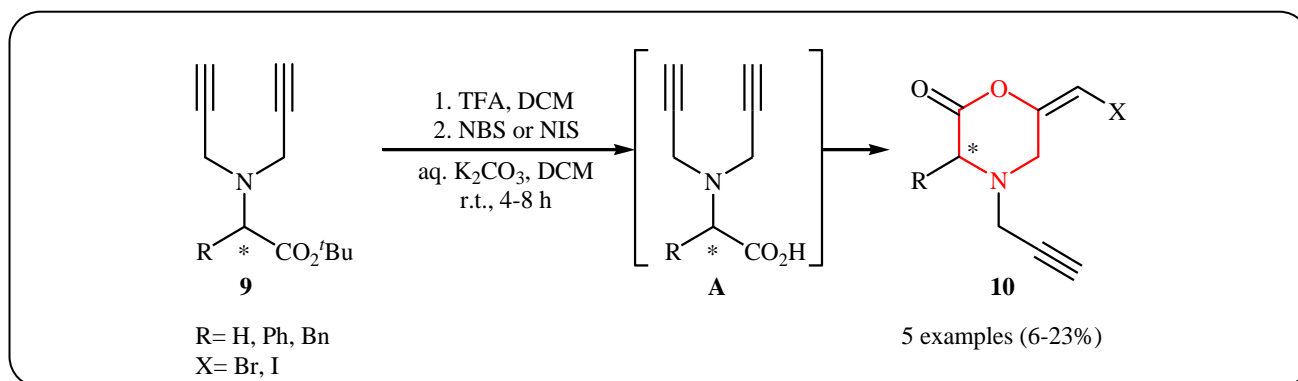
**Scheme 1: Asymmetrical synthesis of haloenol morpholin-2-ones **10** developed by Long.**

can be obtained from the reaction of *N*-propargylamino epoxides **11** with aliphatic alcohols through a gold(I)-catalyzed three-membered ring-opening/6-*exo*-cycloisomerization/ intermolecular nucleophilic addition sequential processes (Scheme 2). [20] This processes were run under mild conditions, tolerated a number of functional groups, and generally provided morpholines **12** in moderate to good yields. Interestingly, when the nucleophilic source was changed from ROH to H₂O, the fused bicyclic ketal skeletons **30** were obtained in moderated yields instead of the desired morpholine products **12** (See Scheme 12).

In a related investigation, S. Fang and co-workers found that *N*-propargylamino epoxides **13** were converted to the corresponding substituted 3,4-dihydro-2-(isopropenyl)-1,4-oxazines **14**, *via* intramolecular cyclization using PtCl₂ as catalyst in refluxing toluene. The hydrolysis of cyclization products **14** using THF/HCl system furnished high yields of corresponding

2-(isopropenyl)morpholines **15** (Scheme 3). The suggested reaction mechanism for cyclization step is outlined in Scheme 4. The reaction of platinum(II) with the alkyne and the sulfonamide moieties of **13** affords intermediate **A**. This intermediate undergoes propargyl–allenyl isomerization to form intermediate **B**. The formation of organometallic intermediate **C** occurs next, that after a protodeplatination process delivers the observed 3,4-dihydro-2-(isopropenyl)-1,4-oxazines **14** with concomitant regeneration of Pt(II) catalyst. [21]

Recently, J. Wang group showed that the 1,4-oxazine derivatives **16** could be synthesized regio- and stereoselectively from amino acid derivative *N*-propargylamino alcohols **15** under catalyst and solvent-free condition at 70 °C. This hydroalkoxylation reaction was run in the presence of 1.0 equiv. of sodium hydride as base and generally provided two chiral carbon centered 1,4-oxazines **16** in moderate to good yields (Scheme 5). This methodology is also well applicable for

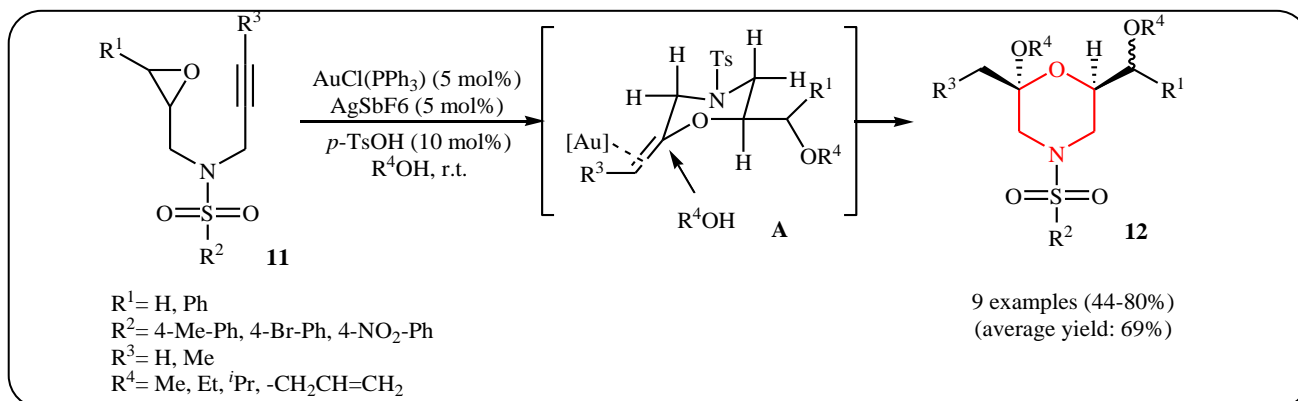

Scheme 2: Synthesis of 2,6-trans-substituted morpholines 12 from the reaction of N-propargylamino epoxides 11 with aliphatic alcohols.

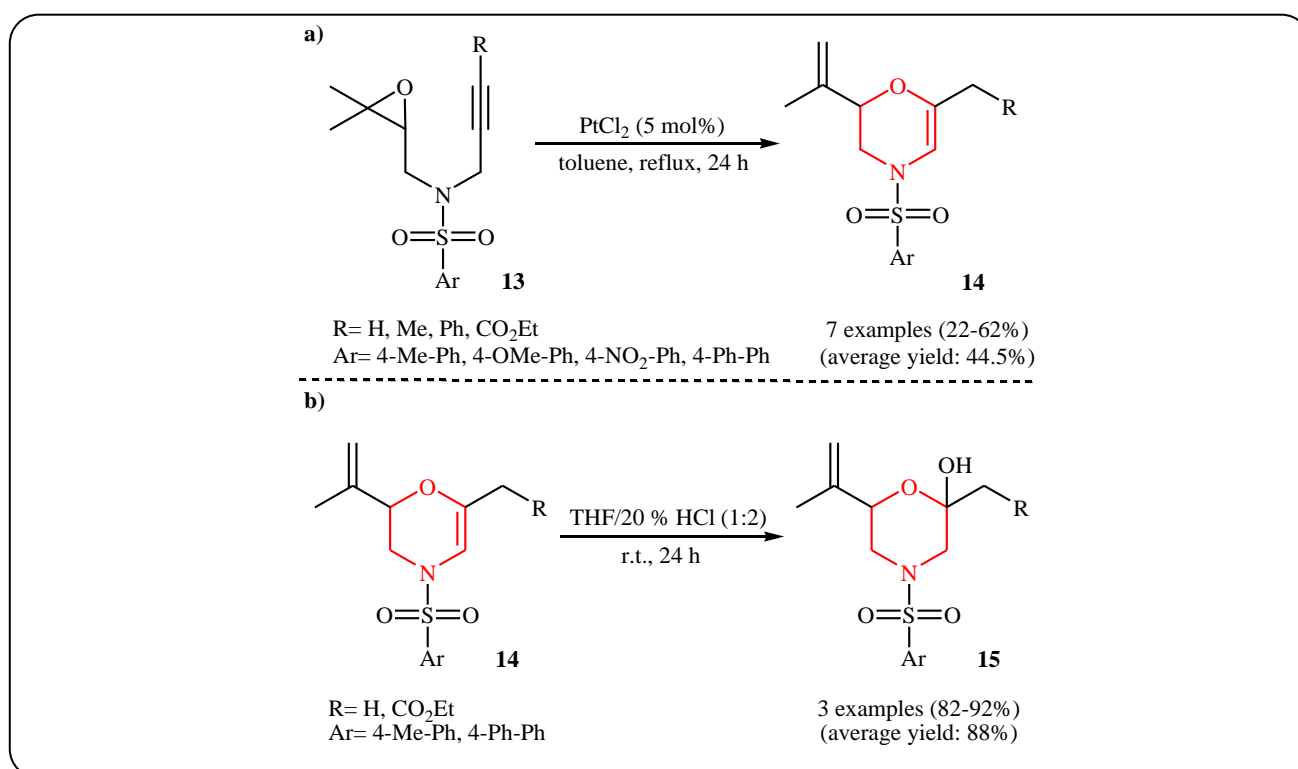

Scheme 3: (a) Pt-catalyzed synthesis of 3,4-dihydro-2-(isopropenyl)-1,4-oxazines 14 ; (b) synthesis of morpholines 15 via hydrolysis of 14.

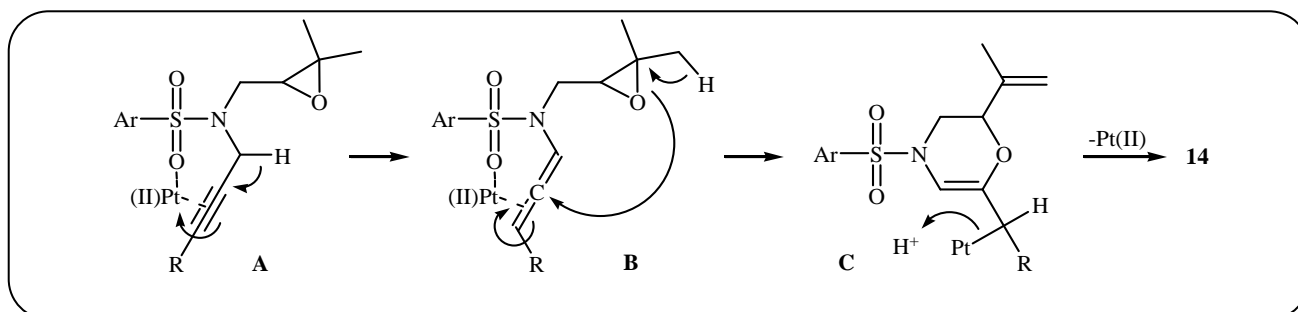

Scheme 4: Mechanism proposed to explain the generation of 14.

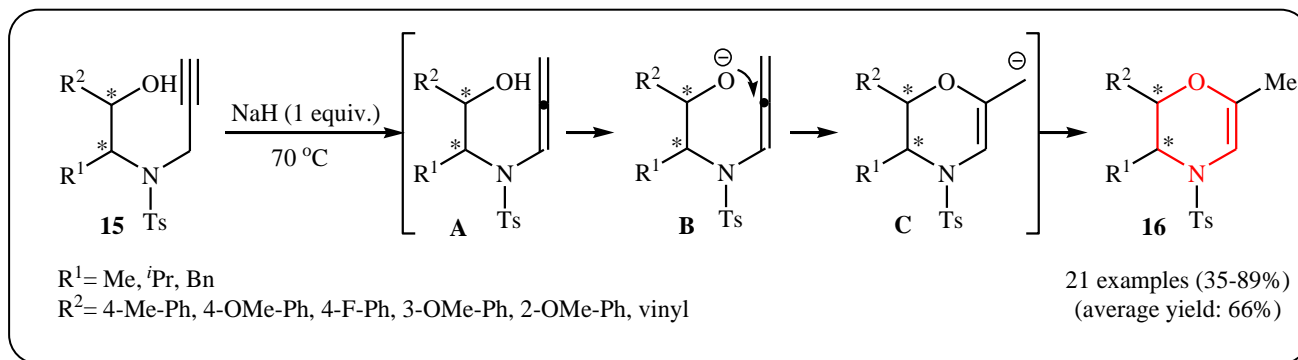

Scheme 5: Asymmetrical synthesis of 1,4-oxazines **16** via NaH-promoted cyclization of chiral alkynyl alcohols **15**.

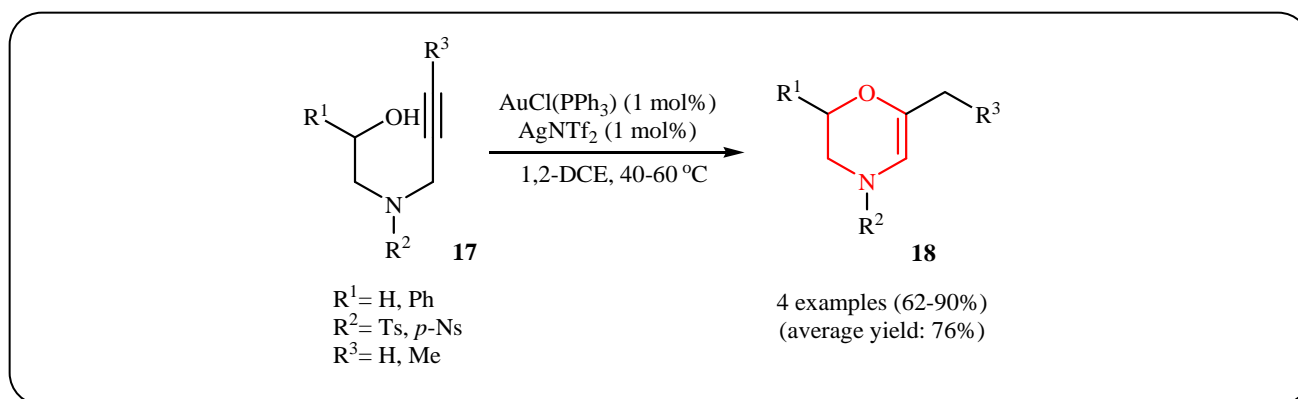

Scheme 6: Gold-catalyzed cyclization reaction of alkynyl amines **17** reported by Huang.

the asymmetrical synthesis of 1,4-oxazepine derivatives. The mechanism of this transformation was proposed based on DFT calculations determining that the reaction proceeds *via* tandem propargyl–allenyl isomerization/deprotonation/6-*exo-dig* cyclization/protonation [22].

In a closely related study, Yao, Wang, and Huang found that *N*-propargylamino alcohols **17** were converted to the corresponding substituted oxazines **18**, *via* heterocyclization using only 1.0 mol% of AuCl(PPh₃)/AgNTf₂ as catalytic system in 1,2-DCE at 40 °C (Scheme 6). The authors showed that the hydrogenation of **18** by using Pd/C as a catalyst resulted corresponding morpholines in excellent yields. [8]

FUSED MORPHOLINE SYSTEMS

3,4-Dihydro-benzo[1,4]oxazines

In 1979, M. Yamamoto made a pioneering and systematic study on the intramolecular cyclization of 2-(propargylamino)phenols (Scheme 7). He found that the mercuryoxide-catalyzed heterocyclization of the

low-cost and readily accessible *N*-substituted 2-(propargylamino)phenols **19** proceeded efficiently in the presence of 4 mol% of mercuric oxide catalyst in refluxing DMF to give the desired 3,4-dihydro-benzo[1,4]oxazines **20** in good yields. However, *N*-H free aminophenols failed to participate in this reaction and gave only decomposition products. [23] Nearly twenty years later, the group of Kundu improved the efficiency of this reaction in terms of yield and reaction time by performing the process in refluxing EtOH/H₂O using KOH as base. [24, 25]

Along this line, recently Manzo and co-workers reported the preparation of a series of *N*-protected and *N*-H free 3,4-dihydro-benzo[1,4]oxazines **22** in moderate to high yields *via* gold(I)-catalyzed cyclization of the corresponding 2-(propargylamino)phenols **21** (Scheme 8a). AuCl was the most efficient catalyst among the various gold catalysts such as NaAuCl₄·2H₂O, PPh₃AuCl, AuCl₃, AuCl₃/AgOTf *etc* for this reaction. The authors also were able to demonstrate that the exocyclic C=C bond substituted benzoxazines can be obtained

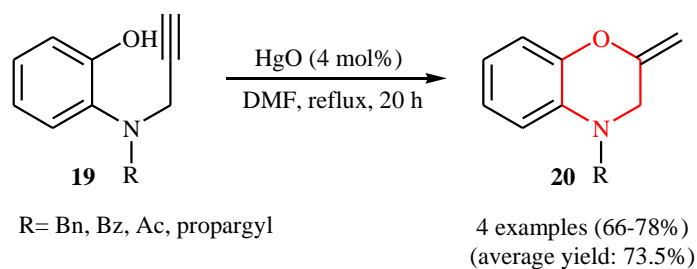

Scheme 7: Synthesis of 3,4-dihydro-benzo[1,4]oxazines 20 developed by Yamamoto.

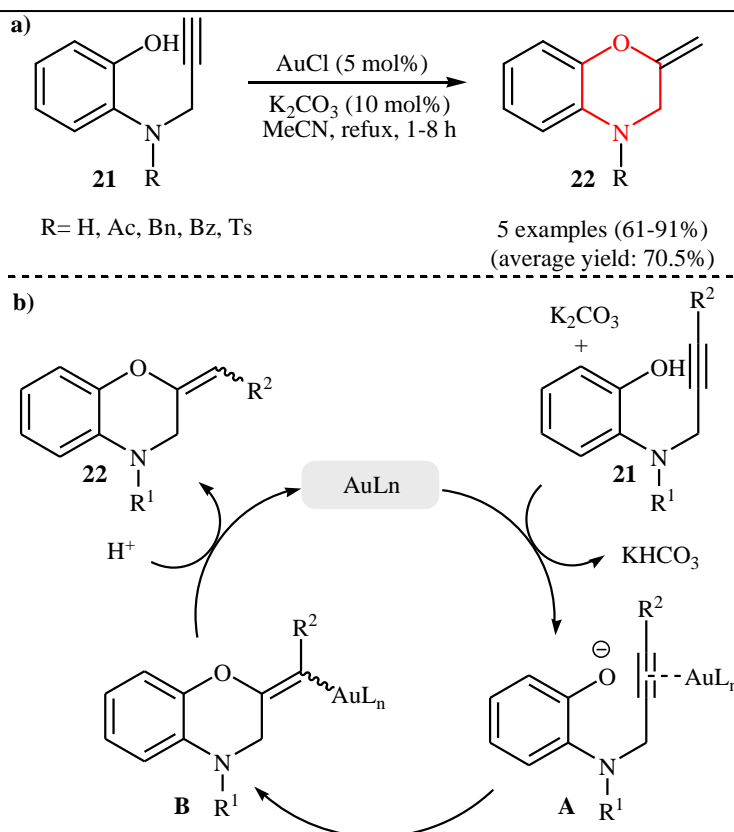

Scheme 8: a) Gold-catalyzed intramolecular hydroalkoxylation of 2-(propargylamino)phenols 21; b) Mechanism that accounts for the formation of 22.

from cyclization of the corresponding internal *N*-propargyl anilines by treatment with AuCl_3 in DMF at 95 °C. The author proposed catalytic cycle for this transformation, which is depicted in Scheme 8b. [26]

The group of H. Seo has recently described a beautiful Pd-catalyzed synthesis of 2-(arylmethylene)-1,4-benzoxazin-3-ones **25** through a one-pot Sonogashira reaction/6-*exo-dig* cyclization sequence from *N*-(2-hydroxyphenyl)propiolamides **23** and aryl iodides **24**

(Scheme 9). The results showed that aryl iodides with electron-withdrawing groups gave higher yields than those with electron-donating groups. Interestingly, the reaction was completely stereoselective and resulted in exclusive formation of the (*Z*)-isomer. [27]

Pyrrolo- and indolomorpholinone derivatives

Recently, Taskaya, Menges, and Balci studied the possibility of synthesizing pyrrolo- and indolomorpholinone

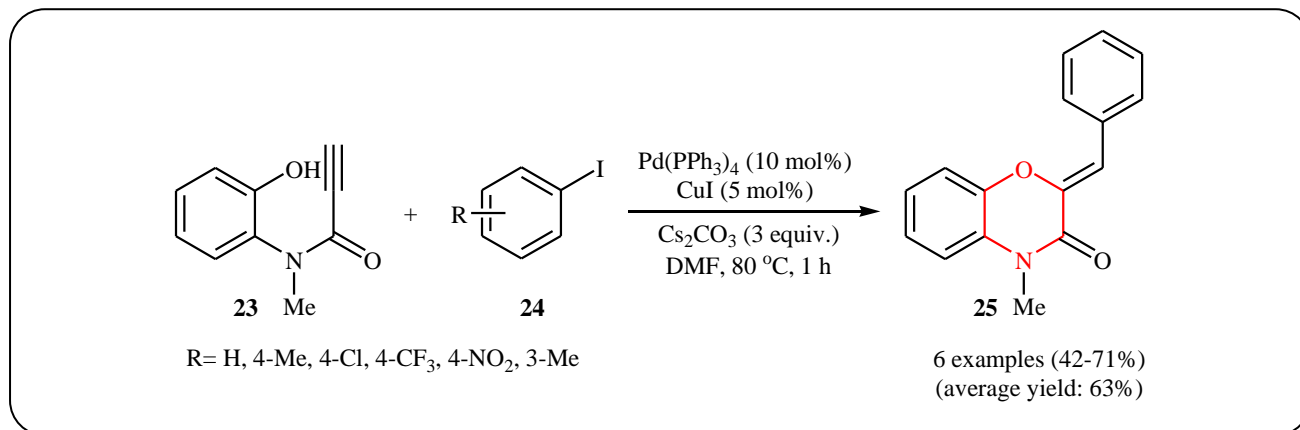

Scheme 9: Synthesis of 2-(arylmethylene)-1,4-benzoxazin-3-ones **25** by one-pot Sonogashira reaction and 6-*exo-dig* cyclization developed by Seo.

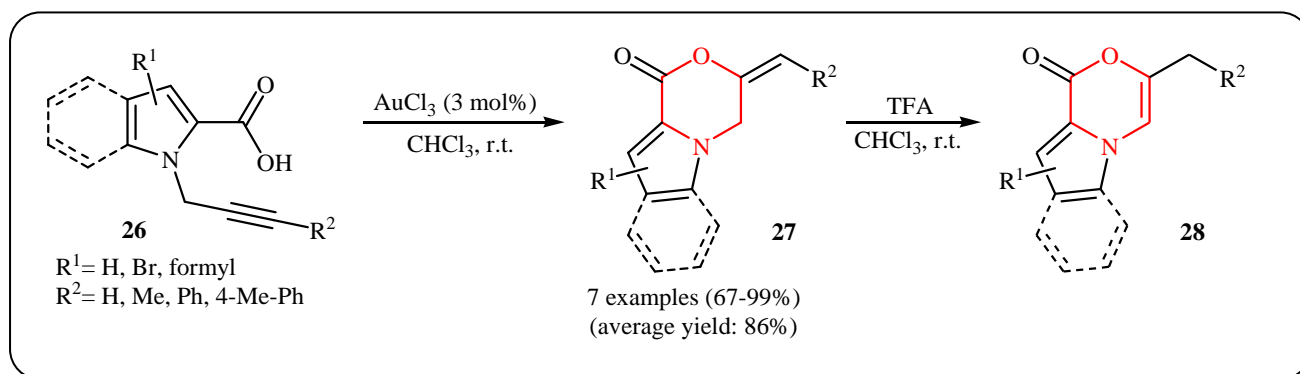

Scheme 10: Au(III)-catalyzed construction of pyrrolo- and indolomorpholinone derivatives **28** developed by M. Balci.

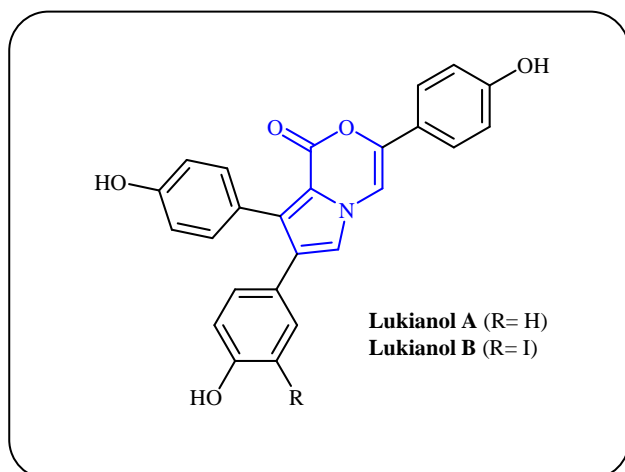

Fig. 2: Chemical structure of Lukianol A and B.

scaffolds **27** from *N*-propargylpyrrole and indolecarboxylic acids **26** through an Au(III)-catalyzed heterocyclization process (Scheme 10). Thus, the careful analysis of the optimized reactions revealed that the optimum condition for this cyclization was the addition of AuCl₃ (3 mol%),

at room temperature, to a solution of **26** in chloroform. The authors found that some of cyclization products **27** in the treatment with trifluoroacetic acid (TFA) underwent isomerization to afford 1,4-oxazines **28** in moderate to good yields. It is noted that these structures are the core skeleton of some marine products such as Lukianol A and Lukianol B (Figure 2). [28]

BRIDGED MORPHOLINE SYSTEMS

In 2007, M. Shi *et al.* reported a new methodology for the synthesis of fused bicyclic ketal derivatives **30** by the reaction between easily available *N*-((oxiran-2-yl)methyl)propargylamines **29** and water as nucleophile (Scheme 11). The reaction was carried out using *N*-propargyl epoxides (0.3 mmol), H₂O (0.45 mmol), AuCl(PPh)₃ (5 mol%), AgSbF₆ (5 mol%) and 1,2-DCE (3.2 mL) at room temperature for 48-72 h. This gold-catalyzed reaction tolerated the presence of various sensitive functional groups, such as bromo, nitro, ester, and silyl groups, and generally provided **30** in moderate yields.

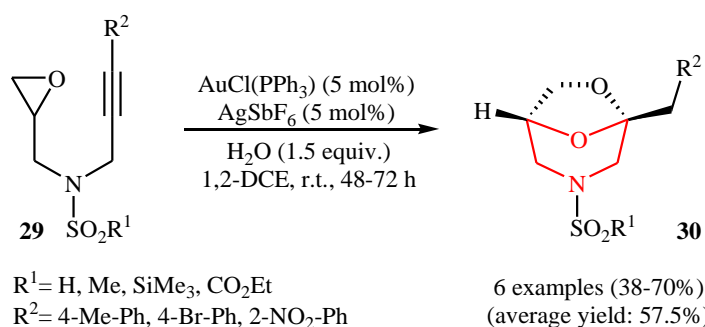

Scheme 11: Au(I)-catalyzed regio- and diastereoselective synthesis of fused bicyclic ketals **30** from *N*-propargyl epoxides **29** and water.

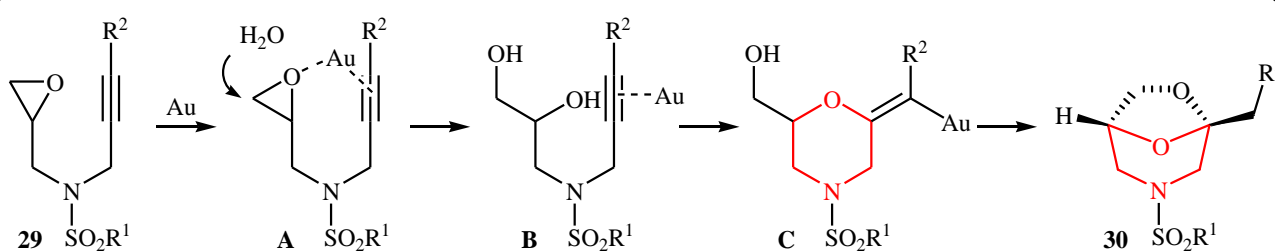

Scheme 12: Mechanism that accounts for the formation of **30**.

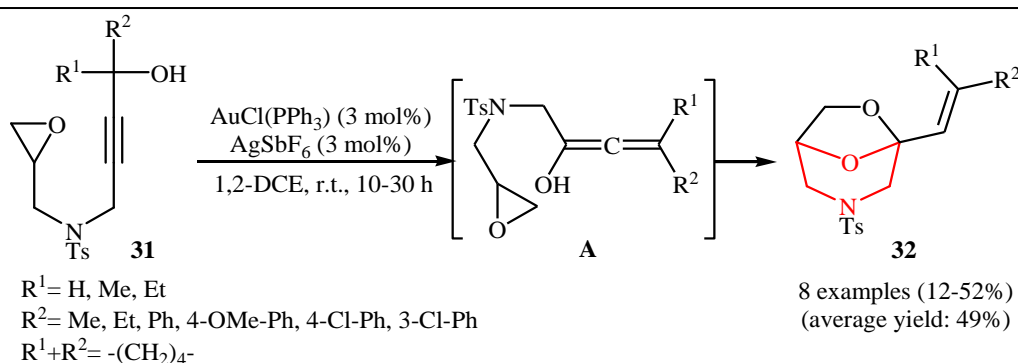

Scheme 13: Au-catalyzed cycloisomerization of epoxy propargylic alcohols **31**.

The mechanism proposed to explain this reaction starts with the generation of the intermediate **A** via coordination of a cationic gold species to the epoxy and alkyne units of **29**, and then an intermolecular nucleophilic attack toward the oxirane by water resulted in an opened oxirane intermediate **B**. The 6-*exo* cyclization of this intermediate gives vinyl gold intermediate **C**. Finally, the intramolecular nucleophilic attack of hydroxy group onto the activated double bond affords observed bicyclic ketals **30** (Scheme 12) [20].

Soon after, the same authors studied the possibility of intramolecular version of this reaction. Thus, a variety of substituted ketals **32** were synthesized via cycloisomerization of epoxy propargylic alcohols **31** employing aforementioned catalytic system (Scheme 13). The results demonstrated that *N*-propargylamines with electron-withdrawing groups gave higher yields than those with electron-donating groups. According to the proposed mechanism, the reaction proceeded through an allenol intermediate **A** [29].

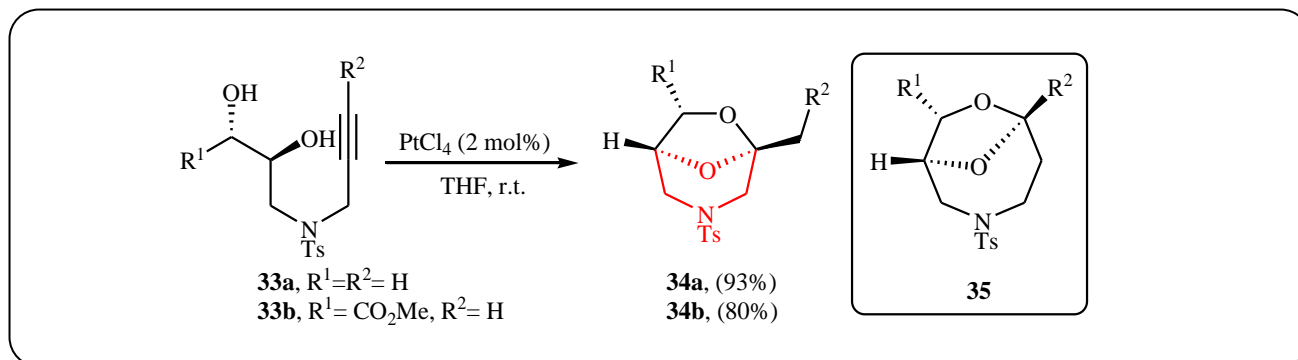

Scheme 14: Pt-catalyzed synthesis of enantiopure fused bicyclic ketal derivatives **34** from chiral *N*-propargylamino diols **33**.

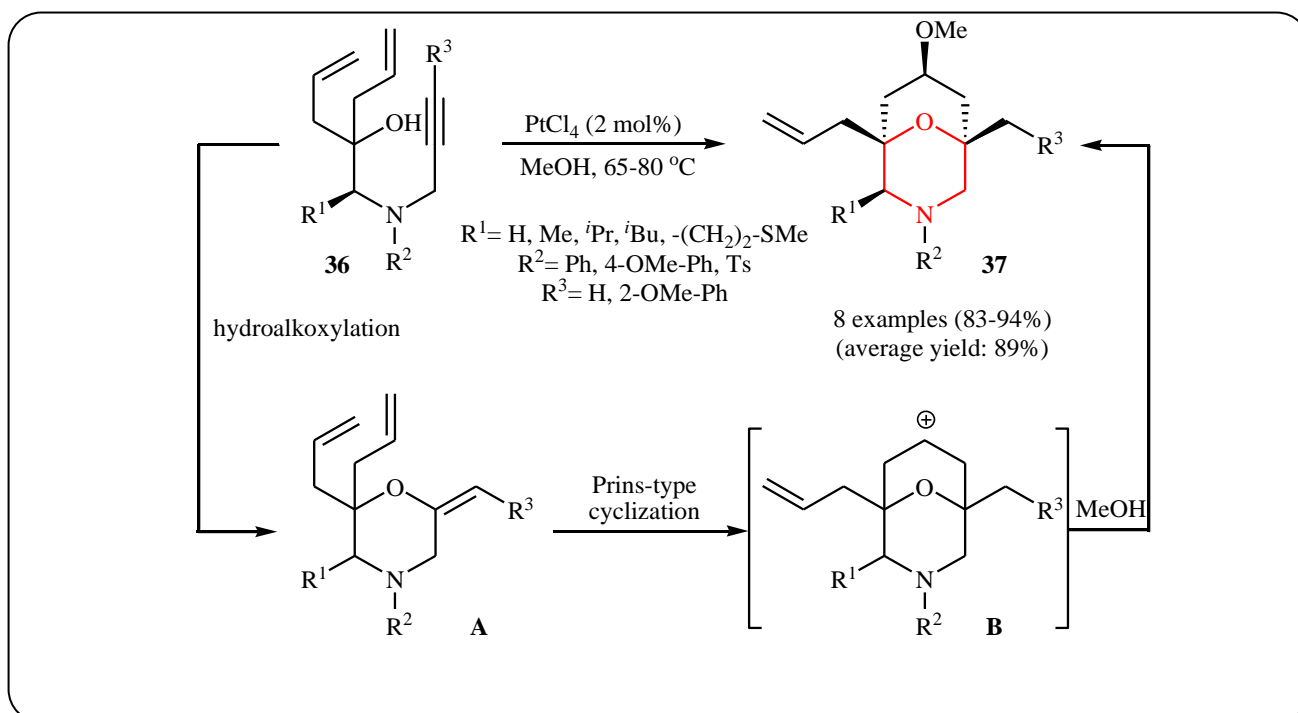

Scheme 15: Pt(IV)-catalyzed synthesis of bicyclic ethers **37** developed by Barluenga.

Subsequently, the S. V. Ley group reported a related strategy toward enantiopure fused bicyclic ketal derivatives **34** from chiral *N*-propargylamino diols **33** employing 2 mol% of $PtCl_4$ as catalyst in THF (Scheme 14). The cyclization reaction proceeded cleanly under very mild conditions, and ketals **34** were obtained in high yields. However, the substrates bearing an internal alkene unit don't work well under this reaction conditions, due to the cyclization reaction gave exclusively [4.2.1] bicyclic ketals **35** via 7-*endo* cyclization or a mixture of [3.2.1] **2** and [4.2.1] bicyclic ketals **3** via both *exo* and *endo* cyclizations. [30]

In 2009, the group of J. Barluenga has reported a beautiful route for the synthesis of complex bicyclic ethers **37** from the reaction of *N*-propargylamino alcohols **36** with methanol, through a Pt(IV)-catalyzed intramolecular hydroalkoxylation/Prins-type cyclization reaction (Scheme 15). In this transformation, methanol serves both as a solvent and a reagent. [31]

Subsequently, B. Alcaide and co-workers reported an example of optically pure tricyclic bridged acetal preparation from *N*-propargylamine. They showed that terminal *N*-propargyl dioxolane **38** underwent an Au-catalyzed cascade 6-*exo*/5-*exo* bis-oxycyclization

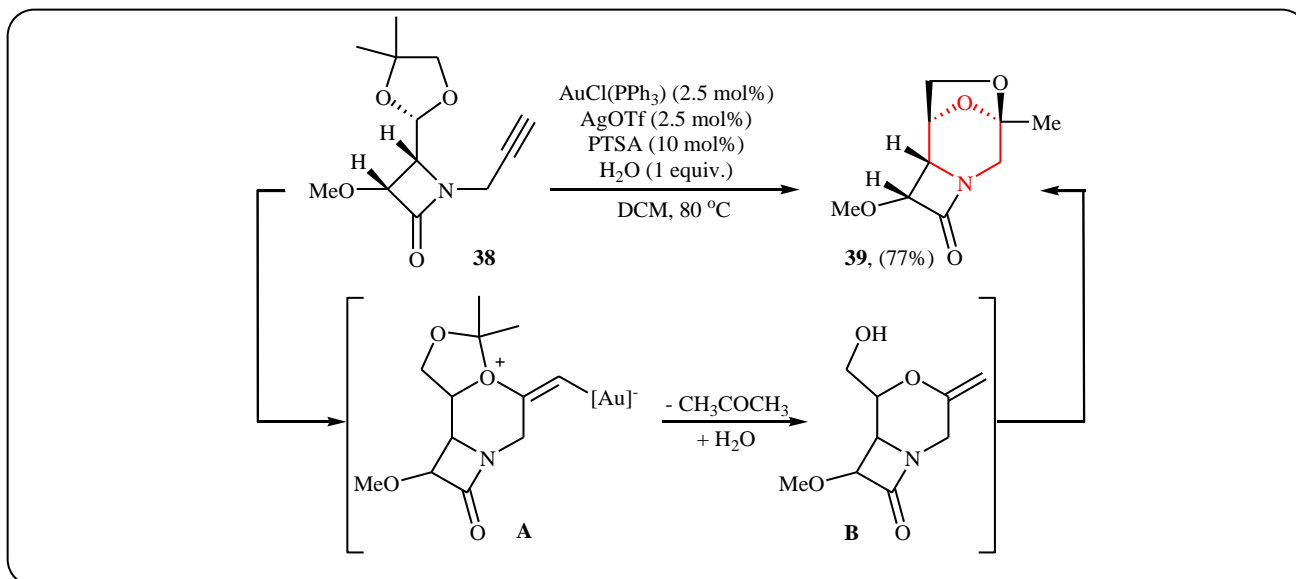

Scheme 16: Synthesis of 6,8-dioxabicyclo[3.2.1]octane **39** through Au-catalyzed cyclo-ketalization reaction of **38**.

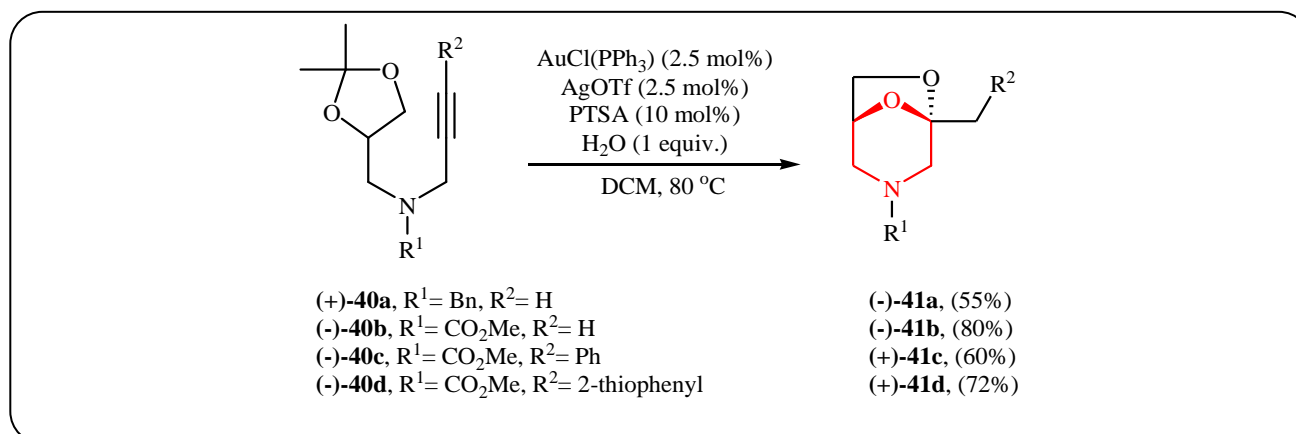

Scheme 17: Cyclo-ketalization reaction of **40**.

in the presence of 2.5 mol% of $\text{AuCl(PPh}_3\text{)}/\text{AgOTf}$ as catalyst, 10 mol% of *p*-toluenesulfonic acid (PTSA) as co-catalyst, 1 equiv. H_2O as additive in DCM at 80 °C. The corresponding 6,8-dioxabicyclo[3.2.1]octane derivative **39** was obtained in 77% yield (Scheme 16). [32] In a similar manner, cyclo-ketalization reaction of *N*-propargylamines **40** gave the corresponding 6,8-dioxabicyclo[3.2.1]octane derivatives **41** in good yields (Scheme 17). [33]

SUMMARY AND OUTLOOK

Polyfunctionalized morpholines are ubiquitous in natural products, pharmaceuticals, and agrochemicals. Therefore, the interest for developing new, versatile and efficient synthesis of morpholine cores has always been

a thread in the synthetic chemistry community. *N*-propargylamines are an important class of alkynes, which can undergo a number of cyclization reactions to produce various *N*-heterocycles. They have been successfully transformed into substituted, fused, and bridged morpholines. This new strategy to synthesis of morpholine derivatives has successfully overcome most of the disadvantages associated with conventional methodologies. It is our hope that this review article will stimulate continued interest in the synthesis of morpholine derivatives from *N*-propargylamines and make it a prolonged and prominent research area for developing highly versatile, extremely effective, and novel methods used for the synthesis of natural and pharmaceutical products.

Received : Mar. 2, 2017 ; Accepted : Apr. 24, 2017

REFERENCES

- [1] (a) Anaraki-Ardakani H., Nekomanesh P., Synthesis of Polyfunctionalized Pyrroles by a PPh₃-Promoted Condensation Reaction between Ammonium Acetate, Dialkyl Acetylenedicarboxylate and Arylglyoxals, *Iran. J. Chem. Chem. Eng. (IJCCE)*, (2017) in press.
- (b) Behmadi H., Moghaddam Z. A., Poormorteza N., Beyramabadi S.A., Nezhad M.A., A four Components, One-Pot Synthesis of New Imidazole Molecular Tweezers Based on 2,4,6-Triarylpyridine as Hinge Region, *Iran. J. Chem. Chem. Eng. (IJCCE)*, **36**(1): 11-17 (2017).;
- (c) Hasaninejad A., Zare A., Zolfigol M.A., Abdeshah M., Ghaderi A., Nami-Ana F., Synthesis of Poly-Substituted Quinolines *via* Friedländer Hetero-Annulation Reaction Using Silica-Supported P₂O₅ under Solvent-Free Conditions, *Iran. J. Chem. Chem. Eng. (IJCCE)*, **30**(1): 73-81 (2011).;
- (d) Beyzaei H., Beygi A., Aryan R., One-Pot Ynthesis and Characterization of Highly Functionalized Thiazoles, *Iran. J. Chem. Chem. Eng. (IJCCE)*, **35**(4): 31-37 (2016).;
- (e) Aboudi J., Bayat Y., Abedi Y., Nabati M., Mahkam M., 3-Nitro, 1-Amino Guanidine and 5-Hydrazino-1H-Tetrazole Derivatives as New Energetic Materials, *Iran. J. Chem. Chem. Eng. (IJCCE)*, **34**(2): 1-16 (2015).
- [2] (a) Somei M., Aoki K., Nagahama Y., Nakagawa K., Simple Synthesis of Marine Alkaloid, (±)-Chelonin A, and Its Analogs, *Heterocycles.*, **41**(1): 5-8 (1995).;
- (b) Guzii A.G., Makarieva T.N., Denisenko V.A., Dmitrenok P.S., Kuzmich A.S., Dyshlovoy S.A., Krasokhin V.B., Stonik V.A., Monanchocidin: A New Apoptosis-Inducing Polycyclic Guanidine Alkaloid from the Marine Sponge *Monanchora pulchra*, *Org. Lett.*, **12**(19): 4292-4295 (2010).
- (c) Tong X.G., Zhou L.L., Wang Y.H., Xia C., Wang Y., Liang M, Hou F.F., Cheng Y.X., Acortatarins A and B, Two novel Antioxidative Spiroalkaloids with a Naturally unusual Morpholine Motif from *Acorus Tatarinowii*, *Org. Lett.*, **12**(8): 1844-1847 (2010).
- [3] Weigelt J., Itani K., Stevens D., Lau W., Dryden M., Knirsch C., Group L.C.S., Linezolid Versus Vancomycin in Treatment of Complicated Skin and Soft Tissue Infections, *Antimicrob. Agents. Chemother.*, **49**(6): 2260-2266 (2005).
- [4] McKeage K., Finafloxacin: First Global Approval, *Drugs.*, **75**(6): 687-693 (2015).
- [5] Hesketh P.J., Grunberg S.M., Gralla R.J., Warr D.G., Roila F., De Wit R., Chawla S.P., Carides A.D., Ianus J., Elmer M.E., The Oral Neurokinin-1 Antagonist Aprepitant for the Prevention of Chemotherapy-Induced Nausea and Vomiting: A Multinational, Randomized, Double-Blind, Placebo-Controlled Trial in Patients Receiving High-Dose Cisplatin—The Aprepitant Protocol 052 Study Group, *J. Clin. Oncol.*, **21**(22): 4112-4119 (2003).
- [6] Hajós M., Fleishaker J.C., Filipiak-Reisner J.K., Brown M.T., Wong E.H., The Selective Norepinephrine Reuptake Inhibitor Antidepressant Reboxetine: Pharmacological and Clinical Profile, *CNS. Drug. Rev.*, **10**(1): 23-44 (2004).
- [7] Asif M., Overview on Emorfazone and Other Related 3(2H)pyridazinone Analogues Displaying Analgesic and Anti-Inflammatory Activity, *Ann. Med. Chem. Res.*, **1**(1): 1-9 (2015).
- [8] Yao L.F., Wang Y., Huang K.W., Synthesis of Morpholine or Piperazine Derivatives Through Gold-Catalyzed Cyclization Reactions of Alkynylamines or Alkynylalcohols, *Org. Chem. Front.*, **2**(6): 721-725 (2015).
- [9] Vessally E., A New Avenue to the Synthesis of Highly Substituted Pyrroles: Synthesis from N-Propargylamines, *RSC Adv.*, **6**(22): 18619-18631 (2016).
- [10] Vessally E., Hosseinian A., Edjlali L., Bekhradnia A., Esrafil M.D., New Page to Access Pyridine Derivatives: Synthesis from N-Propargylamines, *RSC Adv.*, **6**(75): 71662-71675 (2016).
- [11] Vessally E., Hosseinian A., Edjlali L., Bekhradnia A., Esrafil M.D., New Page to Access Pyrazines and their Ring Fused Analogues: Synthesis from N-Propargylamines, *Curr. Org. Synth.*, **14**(4): 557-567 (2017).
- [12] Vessally E., Edjlali L., Hosseinian A., Bekhradnia A., Esrafil M.D., Novel Routes to Quinoline Derivatives from N-Propargylamines, *RSC Adv.*, **6**(55): 49730-49746 (2016).

- [13] Vessally E., Amiri S.S., Hosseinian A., Edjlali L., New Protocols to Access Imidazoles and Their Ring Fused Analogues: Synthesis from N-Propargylamines, *RSC Adv.*, **7**(12): 7079-7091 (2017).
- [14] Vessally E., Hosseinian A., Edjlali L., Bekhradnia A., Esrafil M.D., New Route to 1,4-Oxazepane and 1,4-Diazepane Derivatives: Synthesis from N-Propargylamines, *RSC Adv.*, **6**(102): 99781-99793 (2016).
- [15] Arshadi S., Vessally E., Edjlali L., Ghorbani-kalhor E., Hosseinzadeh-Khanmir R., N-propargylic β -Enaminocarbonyls: A Powerful and Versatile Building Block in Organic Synthesis., *RSC Adv.*, **7**(22): 13198-13211 (2017).
- [16] Arshadi S., Vessally E., Edjlali L., Hosseinzadeh-Khanmir R., Ghorbani-kalhor E., N-Propargylamines: Versatile Building Blocks in the Construction of Thiazole Cores., *Beilstein. J. Org. Chem.* **13**: 625-638 (2017).
- [17] (a) Jiang B., Xu M., Highly Enantioselective Construction of Fused Pyrrolidine Systems that Contain a Quaternary Stereocenter: Concise Formal Synthesis of (+)-Conessine, *Angew. Chem. Int. Ed.*, **43**(19): 2543-2546 (2004).;
- (b) Fleming J.J., Du Bois J., A Synthesis of (+)-Saxitoxin, *J. Am. Chem. Soc.*, **128**(12): 3926-3927 (2006).
- [18] Yamamoto M., Tanaka S., Naruchi K., Yamada K., A Novel Synthesis of 2,3-Dihydro-4H-1,4-Oxazin-2-Ones and 6-mMethylene-2-Morpholinones, *Synthesis.*, (10): 850-852 (1982).
- [19] Mock J.N., Taliaferro J.P., Lu X., Patel S.K., Cummings B.S., Long T.E., Haloenol Pyranones and Morpholinones as Antineoplastic Agents of Prostate Cancer, *Bioorg. Med. Chem. Lett.*, **22**(14): 4854-4858 (2012).
- [20] Dai L.Z., Qi M.J., Shi Y.L., Liu X.G., Shi M., Gold(I)-Catalyzed Cascade Cyclization Reaction: Highly Regio- and Diastereoselective Intermolecular Addition of Water and Alcohols to Epoxy Alkynes, *Org. Lett.*, **9**(16): 3191-3194 (2007).
- [21] Wang Z., Lin X., Luck R.L., Gibbons G., Fang S., Synthesis of Cyclic Allyl Vinyl Ethers Using Pt(II)-Catalyzed Isomerization of Oxo-Alkynes, *Tetrahedron.*, **65**(13): 2643-2648 (2009).
- [22] Vandavasi J.K., Hu W.P., Chen H.Y., Senadi G.C., Chen C.Y., Wang J.J., A New Approach to 1,4-Oxazines and 1,4-Oxazepines via Base-Promoted Exo Mode Cyclization of Alkynyl Alcohols: Mechanism and DFT Studies, *Org. Lett.*, **14**(12): 3134-3137 (2012).
- [23] Yamamoto M., Cyclisation of Phenol- and Enol-Acetylenes : Syntheses of 2,3-Dihydro-2-Methylene-1,4-Benzodioxins and -1,4-Benzoxazines, *J. Chem. Soc., Perkin Trans. 1.*, 3161-3165 (1979).
- [24] Chaudhuri G., Chowdhury C., Kundu, N.G., A Highly Stereoselective Synthesis of (Z)-N-Aryl(alkyl)-2-Arylidene-2,3-Dihydro-1,4-Benzoxazines Through Palladium Catalyzed Reactions, *Synlett.*, (11): 1273-1275 (1998).
- [25] Kundu N.G., Chaudhuri G., Upadhyay A., Palladium-Catalyzed Heteroannulation Leading to Heterocyclic Structures with Two Heteroatoms: A Highly Regio- and Stereoselective Synthesis of (Z)-4-Alkyl-2-Alkyl(Aryl)Idene-3,4-Dihydro-2H-1,4-Benzoxazines and (Z)-3-Alkyl(Aryl)Idene-4-Tosyl-3,4-Dihydro-2H-1,4-Benzoxazines, *J. Org. Chem.*, **66**(1): 20-29 (2001).
- [26] Manzo A.M., Perboni A., Broggin G., Rigamonti M., An Alternative Synthesis of 2-Alkylidene-3,4-Dihydro-2H-1,4-Benzoxazines by Intramolecular Gold-Catalyzed Hydroalkoxylation of 2-(Prop-2-yn-1-Ylamino)Phenols, *Synthesis.*, (1): 127-132 (2011).
- [27] Lee D., Park S., Yu Y., Synthesis of 2-(Arylmethylene)-1,4-Benzoxazin-3-One by One-Pot Sonogashira and 6-*exo-dig* Cyclization, *Heterocycles.*, **91**(8): 1660-1667 (2015).
- [28] Taskaya S., Menges N., Balci M., Gold-Catalyzed Formation of Pyrrolo- and Indolo-Oxazin-1-One Derivatives: The Key Structure of Some Marine Natural Products, *Beilstein J. Org. Chem.*, **11**, 897-905 (2015).
- [29] Dai L.Z., Shi M., A Gold(I)-Catalyzed Intramolecular Reaction of Propargylic/homopropargylic Alcohols with Oxirane, *Chem. Eur. J.*, **14**(23): 7011-7018 (2008).
- [30] Diéguez-Vázquez A., Tzschucke C.C., Lam W.Y., Ley S.V., PtCl₄-Catalyzed Domino Synthesis of Fused Bicyclic Acetals, *Angew. Chem. Int. Ed.*, **47**(1): 209-212 (2008).

- [31] Barluenga J., Fernández A., Diéguez A., Rodríguez F., Fañanás F.J., Gold- or Platinum-Catalyzed Cascade Processes of Alkynol Derivatives Involving Hydroalkoxylation Reactions Followed by Prins-Type Cyclizations, *Chem. Eur. J.*, **15**(43): 11660-11667 (2009).
- [32] Alcaide B., Almendros P., Carrascosa R., Torres M.R., Gold/Acid-Cocatalyzed Regiodivergent Preparation of Bridged Ketals *via* Direct Bis-Oxycyclization of Alkynic Acetonides, *Adv. Synth. Catal.*, **352**(8): 1277-1283 (2010).
- [33] Alcaide B., Almendros P., Carrascosa R., Gold-Catalyzed Direct Cycloketalization of Acetonide-Tethered Alkynes in the Presence of Water, *Tetrahedron.*, **68**(46): 9391-9396 (2012).