

A Comprehensive Comparative Investigation of Compressed Natural Gas as an Alternative Fuel in a Bi-Fuel Spark Ignition Engine

Shamekhi, Amir Hossein⁺; Khatibzadeh, Nima*

Department of Mechanical Engineering, K.N. Toosi University of Technology, Tehran, I.R. IRAN

Shamekhi, Abazar

Department of Mechanical Engineering, University of Tehran, Tehran, I.R. IRAN

ABSTRACT: Nowadays, increased attention has been focused on internal combustion engine fuels. Regarding environmental effects of internal combustion engines particularly as sources of pollution and depletion of fossil fuels, compressed natural gas has been introduced as an alternative to gasoline and diesel fuels in many applications. A high research octane number which allows combustion at higher compression ratios without knocking phenomenon and with good emission characteristics of unburned hydrocarbons and carbon monoxide are major benefits of compressed natural gas as an engine fuel. In this paper, natural gas as an alternative fuel in a spark ignition engine, has been considered. Engine performance and exhaust emissions have been experimentally studied for both natural gas and gasoline fuels in a wide range of engine operating conditions.

KEY WORDS: Alternative fuel, Compressed natural gas, Emission, Gasoline, Performance, Spark ignition engine.

INTRODUCTION

Alternative fuels are of much importance because of strict emission regulations, increasing fuel cost and the dramatic increase in the rate of depletion of crude oil resources. Therefore, car manufacturers are shifting their researches to develop engines that use alternative fuels such as compressed natural gas (CNG) [1]. Some advantages of this fuel over gasoline are:

- Better mixture formation and more uniform combustion.

- Possibility of using higher compression ratios without knocking due to high research octane number of the CNG.

- Lean burning capability of CNG and lowering exhaust emissions.

- Lower fuel cost due to no refinery process.

- Higher durability of engine lubricant.

Abundant resources of natural gas and extensive networks of CNG supply stations throughout some

* To whom correspondence should be addressed.

+E-mail:shamekhi@kntu.ac.ir

1021-9986/08/1/73

11/\$/3.10

countries have encouraged their governments to use CNG as automobile fuel.

Many studies and experimental work have been done on CNG fuelled engines. *Lapetz et al.* [2] developed a Ford CNG bi-fuel pickup truck. To control emissions and insure safety, they modified the base vehicle's configuration for conversion to bi-fuel CNG operation. Natural gas has a lower flame speed than gasoline. This causes the total combustion duration to prolong compared with diesel and gasoline [3].

In designing a turbulent effect in order to increase the natural gas combustion flame speed, *Johansson and Olsson* [4,5] developed ten different geometries of combustion chamber. The results show a high correlation between the cylinder turbulence and rate of heat release in combustion process. However, the results also showed that geometries that gave the fastest combustion would also give the higher nitric oxides (NO_x) concentrations. *Evans, R.L. et al.* [6] investigated combustion chamber design for fast burning of natural gas. Their studies was based on the principle of using squish motion to generate a series of jets directed towards the center of the chamber just prior to ignition. The chamber in this study referred to as the UBC squish jet. The faster burning rate of UBC chamber lead to an average 3 percent reduction in brake specific fuel consumption (BSFC), 5 percent increase in brake mean effective pressure (BMEP), and an increase in the lean limit of combustion. The exhaust emissions were lower for the UBC chamber than those for a conventional bowl-in-piston chamber; brake-specific total unburned hydrocarbon and brake-specific nitric oxides were lower by 20 to 50 percent and brake-specific carbon monoxides were 15 percent lower.

Swain et al. [7] studied the effects of hydrogen addition on the natural gas engine operation. According to their results, adding hydrogen into the CNG-air mixture had negative impact on the combustion delay and increased the combustion burning rate. *Zuo and Zhao* [8] developed a quasi-dimensional model for analysis of combustion process in spark ignition (SI) prechamber natural gas engine. They have used two submodels to simulate turbulence intensity in cylinder and modeling of jet orifices in prechamber. They verified their simulation code with experimental data. Performance and emission characteristics of a bi-fuel Ricardo single cylinder SI research engine have been comparatively studied by *Evans and*

Blaszczyk [9]. Their results show 12 percent reduction of power and 5-50 percent reduction of emissions when the engine is fuelled by natural gas. *Sun et al.* [1] developed General Motors 2.2L CNG bi-fuel passenger car. They used a computer engine simulation model able to predict engine performance, fuel consumption and emissions to reduce system calibration time as well as the cost of testing. According to the results of the experiments, CNG engines showed significantly lower non-methane organic gases, carbon monoxide (CO), NO_x in their emissions than gasoline operated engines. *Manivannan et al.* [10] studied lean burn strategy for reducing emissions of natural gas SI engines. Their experiments included the study of performance and emissions characteristics of an SI lean burn natural gas engine. Also, they studied effects of fuel composition, combustion chamber geometry, combustion modeling, burning rate models, pre-chamber and after-treatment on these engines.

Chiodi et al. [11] have investigated mixture formation and combustion process in a CNG engine by using a fast response three dimensional computational fluid dynamics (CFD) simulation. An improved mathematical model of SI engines was developed by *Shamekhi and Ghaffari* [12] for simulation of engine performance and emissions fuelled by different fuels such as CNG, gasoline and liquid petroleum gas (LPG). This model is based on a combination of thermodynamics relations and dynamical characteristics of the engine during the four strokes. *Volpato et al.* [13] studied engine management for multi-fuel plus CNG vehicles. *Aslam et al.* [14] have retrofitted a conventional 1.5L, 4-cylinder Proton Magma gasoline engine for running with CNG. They tested the bi-fuel engine for CNG and gasoline fuels and measured BMEP, BSFC and fuel conversion efficiency in steady state condition with wide open throttling (WOT) and variable load of 25-65 % of engine full load. Also, a comparative study of emissions has been made for both fuels.

In addition to the advantages of natural gas in vehicle applications, the suitability of natural gas for vehicular applications will depend on the ability to store adequate amount of it in the onboard fuel tank. Natural gas may be stored by liquefaction, compression, or adsorption [15]. For use as a transportation fuel, liquefaction is impractical, since liquefied natural gas (LNG) is usually stored as a boiling liquid at about 112K (-161 °C) in a cryogenic tank at a pressure of about 0.1 MPa. Although

liquefaction of the fuel is possible at cryogenic temperatures, the specialized container design and refuelling procedures required are undesirable for vehicular fuel applications [16].

Moreover, in the compression method the natural gas is stored as a compressed supercritical fluid at room temperature and at high maximum pressures of about 20-25 MPa and an extensive multi-stage compression facility is required. Generally, the use of natural gas as CNG has some disadvantages, for example the CNG storage tanks must be pressure vessels and are thus constrained in their geometry and are also rather heavy. Furthermore, attainment of high pressures (>20 MPa) requires costly multi-stage compression. These problems may be overcome if adequate natural gas energy density under conditions of low pressure and room temperature can be attained, as it appears with adsorbed natural gas (ANG) [16].

Natural gas can be stored as an adsorbed phase in porous materials which is referred to the ANG. This option can be an interesting alternative that overcomes the above-mentioned problems of CNG. The use of adsorbent materials in a storage vessel to store natural gas, at relatively low pressures (3.5-4 MPa) and at room temperature, is a possibility to make natural gas vehicles competitive with other types of vehicles. There are two classes of microporous solids widely used in adsorbed natural gas vehicles: zeolites and activated carbons (including carbon materials with different morphologies such as physically activated carbon fibers (ACFs), chemically activated carbons (ACs), powdered activated carbons (PACs) and activated carbon monoliths (ACMs) [15,16].

Nevertheless, since the natural gas is composed of about 95 % of methane mixed with other components, an important deterioration of the performance is observed after successive cycles of charging and discharging in ANG vehicles. This fact is attributed to the adsorption of the other components existing in the natural gas that are mainly higher-molecular weight hydrocarbons, carbon dioxide and nitrogen. However, modifications in the working conditions make it possible to restore the initial performance. As a case in point, at the end of the discharge when the pressure is equal to 0.1 MPa, heating the vessel to a temperature about 473 K entails a partial desorption of the different species [17].

Regarding ANG, there are mathematical models developed for understanding the temperature and adsorbed mass profiles (for example: no-flow models, flow models with uniform adsorption and flow models with local adsorption) during charging of ANG vehicle systems [18].

The purpose of the present study is to analyze performance and emission characteristics of a Mazda bi-fuel (gasoline + CNG) four-stroke SI engine over a wide range of engine operations. All of tests have been done under steady state conditions for both gasoline and CNG fuels and detailed comparison has been made between results.

Although the engine is equipped with a catalyst converter, the results were measured before the catalyst converter and it is set up only for providing tests with more real conditions like back pressure produced by catalyst. A common rail fuel injection system is used for CNG in order to have precise air-fuel ratio control.

EXPERIMENTAL IMPLEMENTATION

Emissions and performance characteristics of the bi-fuel engine are measured in full load (WOT) and part load conditions over a wide range of engine speeds according to ISO-1585 testing procedure. Test facilities consist of:

- Four cylinder SI engine
- Eddy current dynamometer, Ricardo FE 760-S
- Exhaust gas analyzer, Pierburg HGA 400
- Fuel temperature control device, AVL 753
- CNG mass flow meters, Emerson micro motion elite sensor
- Gasoline mass flow meters, AVL 753
- Fuel consumption device, AVL 733S
- Mazda on-board diagnostics (OBD II) device
- Data acquisition system, Ricardo
- CNG kit, PRINS (VSI)
- CNG storage

The engine and dynamometer specifications are listed in tables 1 and 2. Moreover, the layout of the experimental setup is shown in Fig. 1. The test engine is converted from a gasoline engine (Mazda B2000i) to a bi-fuel (CNG + gasoline) engine and equipped with a suitable bi-fuelling system. In order to achieve desired data, sensors were mounted in suitable positions. Applied sensors were: angle encoder, lambda, MAF (air mass

Table 1: Mazda B2000i engine specifications.

Engine type	Four stroke, Spark ignition
Induction	Naturally aspirated
Number of cylinders	4 cylinder- In line
Bore (mm)	86
Stroke (mm)	86
Connecting rod length (mm)	153
Displacement volume (cm ³)	1998
Compression ratio	8.6
Max. power	70 kw @ 5000 rpm
Max. torque	151 N.m @ 2500 rpm
Valve per cylinder	3
Intake valve opening	10° BTDC
Intake valve closing	49° ATDC
Exhaust valve opening	55° BBDC
Exhaust valve closing	12° ATDC

Table 2: Ricardo dynamometer specifications.

Dyno. type	Ricardo FE 760-S
Max. torque (N.m)	610
Max. speed (rpm)	12000
Max. power (kw)	191.17
Inertia (kg/m ²)	0.176
Torsional spring (N.m/rad)*1000	239
Weight (kg)	474

flow meter), intake manifold temperature, oil temperature and pressure, fuel temperature and pressure, exhaust manifold temperature and outlet water temperature. Data were collected simultaneously from sensors and sent to a data acquisition system. Also, data from engine torque and exhaust gases were recorded which included the concentration of NO_x, total unburned hydrocarbons (THC), CO, CO₂ and O₂ in exhaust emissions. Electronic control unit (ECU) data such as injection time, injection duration and spark advance were monitored by Mazda OBD II device.

Tests have been done for both CNG and gasoline fuels under engine steady state conditions. When CNG kit

was installed on the engine, calibration was done for CNG operation. CNG kit consisted of: pressure regulator, common rail injector, CNG ECU, spark advancer, emulator, CNG filter and fuel exchange switch.

The composition and properties of CNG and gasoline used in these tests were obtained from Iran's Research Institute of Petroleum Industry (RIPI). Gasoline properties are shown in tables 3 and 4. Natural gas properties and composition are shown in tables 5 and 6 (test method: ASTM D-1945-03)

TEST RESULTS AND DISCUSSION

The engine has been tested for CNG and gasoline over a range of 1500-5500 rpm engine speeds. The tests have been done in full load and part load conditions. Various data such as engine performance parameters, exhaust emissions, pressures and temperatures in some critical points and ECU data have been measured.

Investigation of engine performance characteristics

Fig. 2 shows the engine volumetric efficiency for both fuels. According to the figure, volumetric efficiency (the actual air mass per swept volume mass at ambient conditions [19]) of CNG fuelled engine is lower than gasoline fuelled engine. This decrease is due to the larger volume of inlet air occupied by CNG. Using ideal gas state equation it can be easily shown that the volume occupied by natural gas is larger than that by gasoline in a stoichiometric air-fuel mixture. There are several ways to improve engine volumetric efficiency while operating with natural gas such as increasing the number of intake valves per cylinder, valve timing and lifting optimization [20], using turbocharged CNG engine [21,22] and designing a modified intake manifold, however these all affect cost and reliability.

According to Fig. 2, maximum decrease of volumetric efficiency for CNG is about 13.3 % and occurs at engine speed 4000 rpm and its average value is about 12.3 % throughout the engine speed range.

Figs. 3 and 4 compare the engine torque and power for operating with CNG and gasoline. According to the experimental results, these parameters are decreased in CNG fuelled engine. The major reason for the lower torque and power of CNG fuelled engine is the lower volumetric efficiency. Decrease of volumetric efficiency in CNG engines causes reduction in amount of fuel

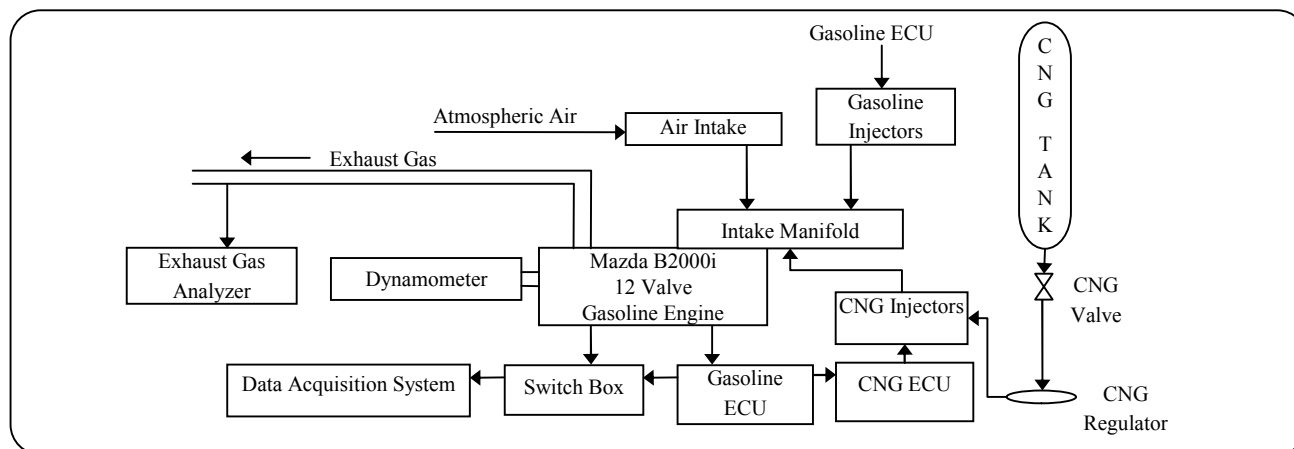

Fig. 1: Layout of the experimental setup.

Table 3: Gasoline composition (source: RIPI).

Component	Symbol	Mass Fraction*100
Carbon	C	85.65
Hydrogen	H	12.94
Oxygen	O	1.39
Sulphur	S	0.0003

Table 4: Thermodynamic properties of gasoline (source: RIPI).

Stoichiometric ratio	14.19
Octane number	95.8
Higher heating value (MJ/kg)	45.03
Lower heating value (MJ/kg)	42.21
Density @ 25 °C (kg/m ³) (DIN 51757)	749
Molecular weight (kg/kmol)	106.22

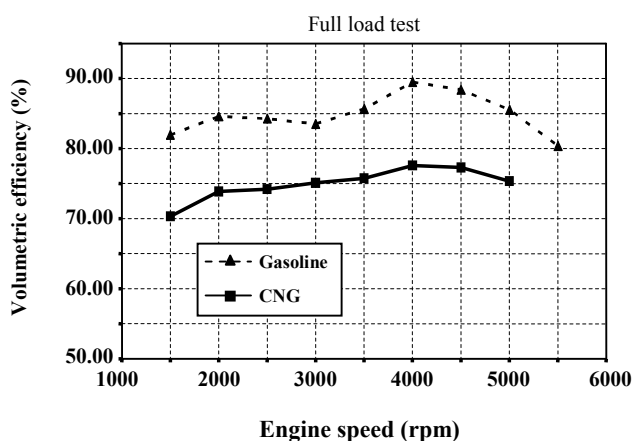

Fig. 2: Engine volumetric efficiency versus engine speed in full load condition for both fuels.

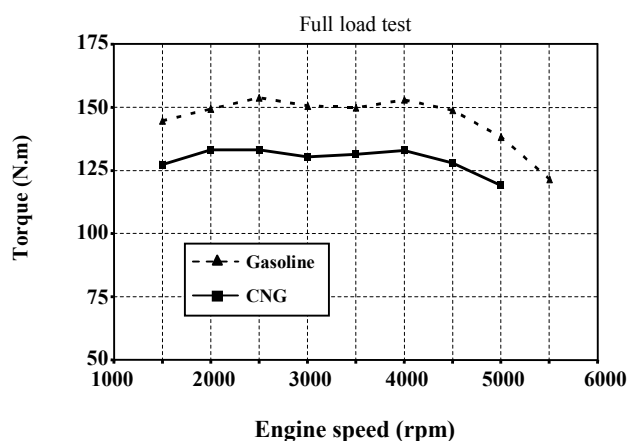

Fig. 3: Engine torque versus engine speed in full load condition for both fuels.

injected into each cylinder per cycle and consequently decreases engine torque and power.

Fig. 5 shows BMEP curves for CNG and gasoline. It can be observed that BMEP curve of CNG is lower than gasoline BMEP curve. The relationship between engine BSFC and engine speed in full load condition is depicted in Fig. 6 for both fuels. According to this figure,

the BSFC increases with the engine speed because the friction power rises in higher speeds. Indeed, in this work, at higher speeds the engine air-fuel ratio decreases, resulting in higher fuel consumption. The BSFC of natural gas has been measured lower than that of gasoline. This fact is attributed to the higher heating value and leaner combustion of CNG compared to gasoline.

Table 5: Thermodynamic properties of natural gas (source: RIPI).

Stoichiometric ratio	16.5
Higher heating value (MJ/kg)	50.79
Lower heating value (MJ/kg)	45.71
Molecular weight (kg/kmol)	18.10

Table 6: Natural gas composition (source: RIPI).

Component	Symbol	Volumetric %
Methane	CH ₄	88.1
Ethane	C ₂ H ₆	4.2
Propane	C ₃ H ₈	1.36
Butane	C ₄ H ₁₀	0.3
Iso-Butane	C ₄ H ₁₀	0.28
Pentane	C ₅ H ₁₂	0.06
Iso-Pentane	C ₅ H ₁₂	0.09
Hexane	C ₆ H ₁₄	0.03
Carbon dioxide	CO ₂	0.3
Nitrogen	N ₂	5.2

The maximum difference of BSFC is 23.8 % and it occurs at 2000 rpm. In average, CNG showed around 19.1 % lower BSFC than gasoline throughout the engine speed range in full load condition.

Fig. 7 illustrate the BSFC for both fuels in part load condition for three different engine speeds. The partial load varies in range 25-75 % of full load. According to the figure, the BSFC has been reduced with increasing of the partial load because of the decrease in pumping loss. As partial load rises, the throttle opens wider therefore the manifold pressure is increased and pumping loss decreased. Also, it is seen that the BSFC rises as engine speed increases. This is due to reduction of air-fuel ratio according to the ECU strategy and increase of friction losses in higher engine speeds.

The air-fuel ratio is determined by ECU strategy. In this work, two individual ECUs are used, one for CNG and the other for gasoline engine operation control. The ECU of CNG itself has the high level integration into the gasoline management system, they are master-slave.

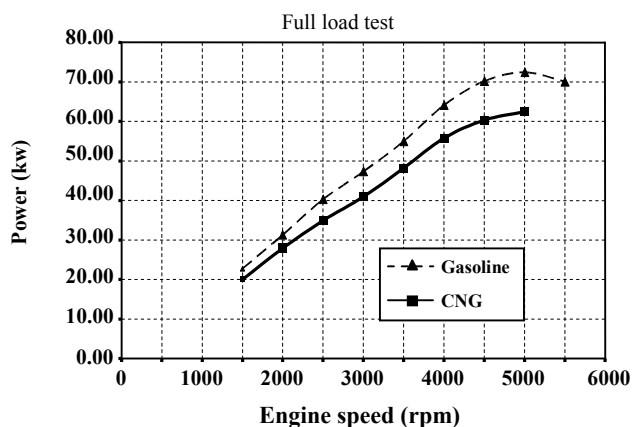
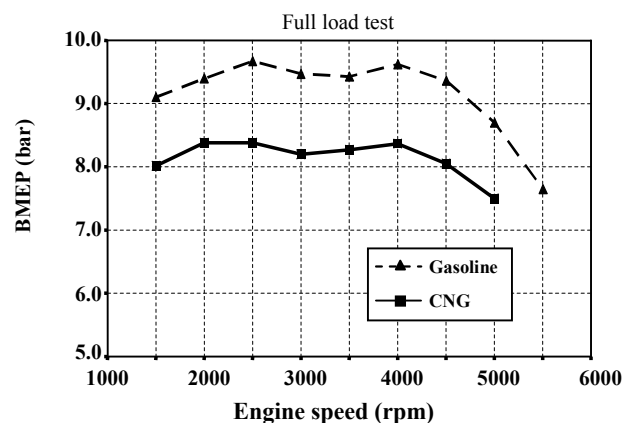
**Fig. 4: Engine power versus engine speed in full load condition for both fuels.****Fig. 5: BMEP versus engine speed in full load condition for both fuels.**

Natural gas ECU (slave) gets some data from gasoline ECU (master) to determine the air-fuel ratio, injection timing and pulse width. Considering the fact that Tehran stands at pressure of 860 mbar, the obtained results clearly conclude that the calibration of gasoline ECU has not been done for that climate but rather for 1000 mbar or sea level. This difference of pressure causes lower density of air induced to engine and consequently rich burning. In this work, there was no possibility of gasoline ECU calibration and the calibration was done only for CNG one. The engine air-fuel ratio was optimized for ECU of CNG. At engine speeds of 1500-3500 rpm which is the most engine operation range of this pick up vehicle, in average the air-fuel ratio is about 0.98 for the CNG fuelled engine. In higher engine speeds, the engine burns rich for attaining sufficient torque and power with CNG fuel.

Fig. 8 shows percent variation of some engine performance parameters such as: torque, power, break mean effective pressure and volumetric efficiency over

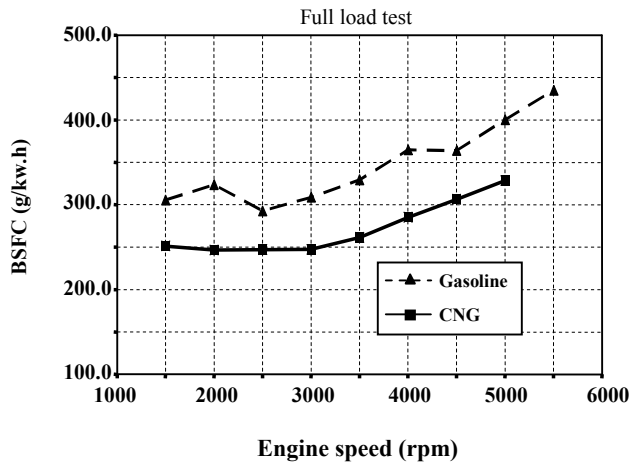

Fig. 6: BSFC versus engine speed in full load condition for both fuels.

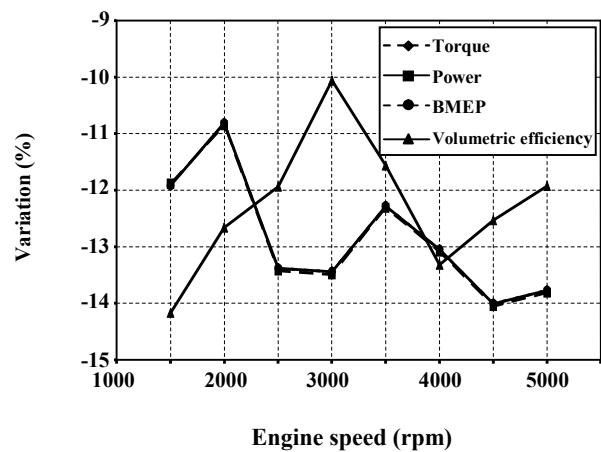

Fig. 8: Variation of engine torque, BMEP, power and volumetric efficiency for CNG compared with gasoline.

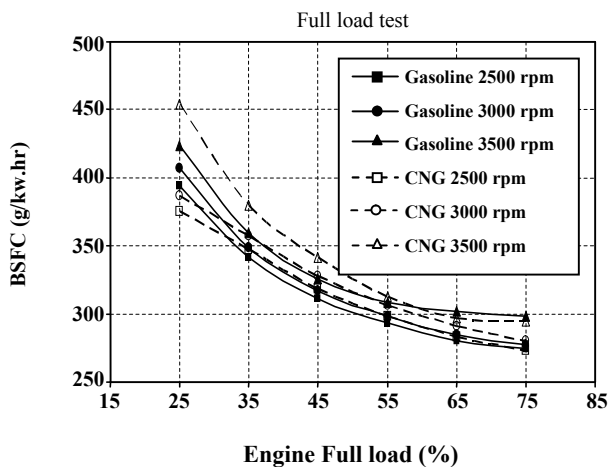

Fig. 7: BSFC versus engine speed in part load condition for both fuels at speeds 2500, 3000 and 3500 rpm.

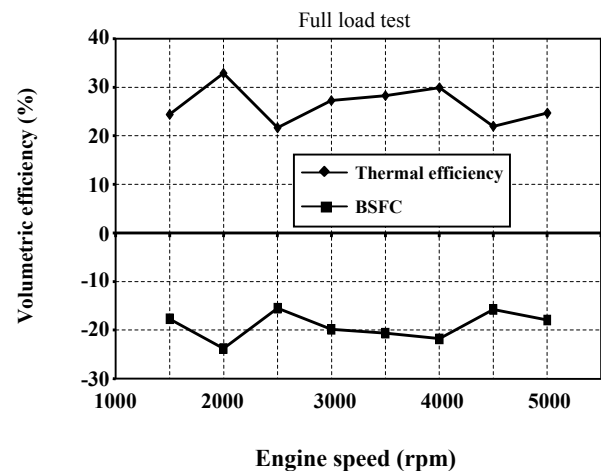

Fig. 9: Variation of thermal efficiency and BSFC for CNG compared with gasoline.

engine speed in full load condition. For engine torque, power and BMEP, the maximum decrease of about 14 % occurs at 4500 rpm. Around 13.3 % decrease of these parameters is observed at 2500 rpm at which maximum engine torque occurs. Volumetric efficiency shows maximum decrease of 13.3 % at 4000 rpm, except at 1500 rpm, which is considered a low engine speed. The variations of maximum values of engine performance characteristics in full load condition have been listed in table 7.

Fig. 9 shows the percentage in variation of the thermal efficiency and BSFC for both fuels in full load condition. Maximum decrease of engine BSFC for CNG fuel compared with gasoline is about 24 % at 2000 rpm.

Thermal efficiency increases in CNG fuelled engine due to higher CNG calorific value and lower engine fuel consumption. This increase shows maximum value of 32 % at 2000 rpm.

Investigation of variations in engine emissions characteristics

In this section, the effect of fuel type on engine exhaust gases has been considered. The presented results show emissions before catalyst converter. Figs. 10 and 11 show relationship of CO₂ and CO to engine speed for CNG and gasoline fuels in full load condition.

The amount of CO₂ in combustion of hydrocarbons is proportional to carbon to hydrogen ratio. The main

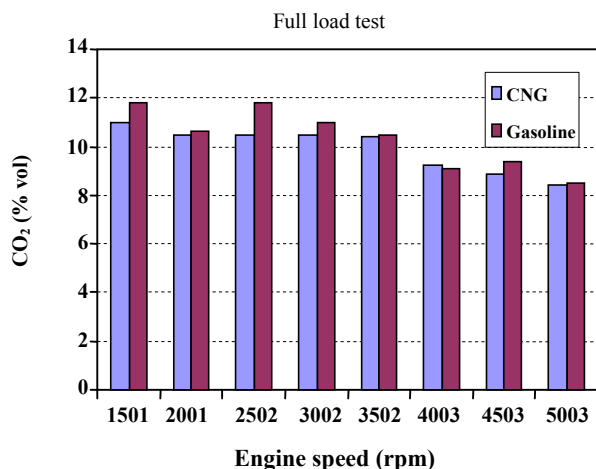

Fig. 10: Comparison of CO₂ in exhaust gases for CNG and gasoline fuels.

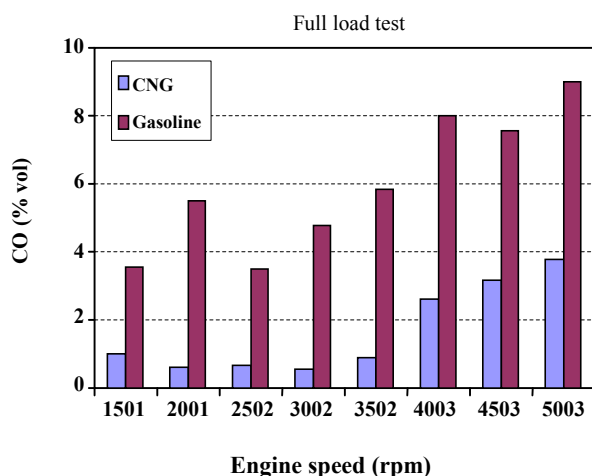

Fig. 11: Comparison of CO in exhaust gases for CNG and gasoline fuels.

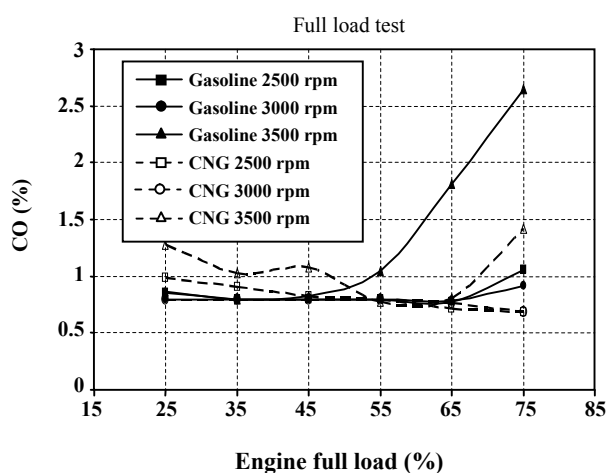

Fig. 12: Comparison of CO in exhaust gases for CNG and gasoline fuels in part load condition at 2500, 3000, 3500 rpm.

component of natural gas is methane which has the lowest carbon to hydrogen ratio compared to other hydrocarbons. Therefore, the resulting CO₂ in CNG combustion is less than gasoline.

The amount of CO is a function of air-fuel ratio. In fact, as air-fuel ratio gets closer to stoichiometric condition, the amount of CO emission becomes less. The air-fuel ratio of CNG fuelled engine is closer to stoichiometric condition, consequently CO emissions are decreased with CNG.

Fig. 12 demonstrate CO emissions for both fuels in part load condition. It is shown that the CO emissions rise in higher engine loads and speeds because the air-fuel ratio drops in these conditions. The CO concentration is highly related to the lambda strategy. Therefore, there are some deviations in CO emission in different speeds and loads.

Figs. 13 and 14 compare the THC emissions for operation with both fuels in full load and part load conditions, respectively. According to these figures, there are some reductions in the THC concentration with CNG operation. These reductions are due to higher temperatures of combustion and exhaust gases and lower fuel trapping phenomenon in crevices while engine operates with CNG.

Fig. 15 reveals the NO_x emissions for both fuels in full load condition. According to the obtained results, the NO_x emissions are increased with CNG fuel. The formation process of the NO_x emissions is strongly temperature dependent and this increase is partly due to the higher natural gas combustion temperature. There are two main reasons for this increase in temperature. First, the elimination of the cooling effect of liquid fuel vaporization and second, more spark advance which is used to compensate for lower natural gas flame speed which rises peak of combustion temperature. In this work the spark is between 7 and 13 crank angle more advanced for natural gas than gasoline in full load condition. Furthermore, lean mixture is another reason for more NO_x emissions in internal combustion engines. According to the ECU strategy, the engine is leaner with CNG than with gasoline in average about 13.7 % throughout speed range. It has a significant impact on the higher NO_x. The simple chemical bond of CNG compared to gasoline is also a reason of producing more NO_x than gasoline [14].

Table 7: Variations of engine performance parameters.

	Gasoline	CNG	Deviation
Max. power (kw)	72.44 @ 5000 rpm	62.44 @ 5000 rpm	13.8 %
Max. torque (N.m)	153.81 @ 2500 rpm	133.23 @ 2500 rpm	13.3 %
Max. volumetric efficiency	89.51 % @ 4000 rpm	77.59% @ 4000 rpm	13.3 %
Max. BSFC (g/kw.h)	434.9 @ 5500 rpm	328.5 @ 5000 rpm	_____
Max. BMEP (bar)	9.67 @ 2500 rpm	8.38 @ 2500 rpm	13.3 %
Max. thermal efficiency %	27.34@2500 rpm	34.76@2000 rpm	_____

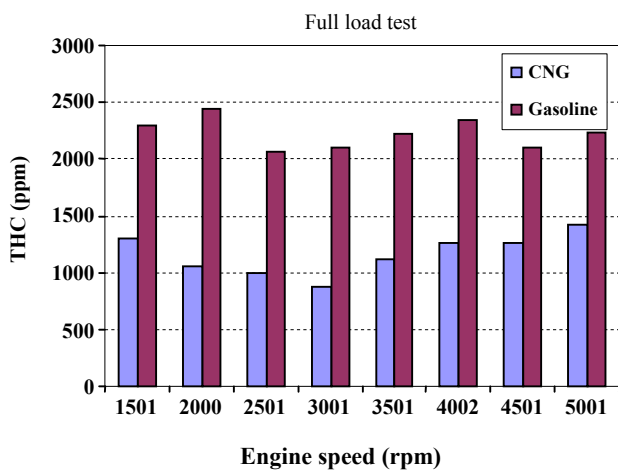

Fig. 13: Comparison of HC in exhaust gases for CNG and gasoline fuels.

Fig. 15: Comparison of NO_x in exhaust gases for CNG and gasoline fuels.

Fig. 14: Comparison of THC in exhaust gases for CNG and gasoline fuels in part load condition at 2500, 3000, 3500 rpm.

Fig. 16: Comparison of NO_x in exhaust gases for CNG and gasoline fuels in part load condition at 2500, 3000 and 3500 rpm.

There are many ways for reducing the NO_x emissions such as: ultra lean burning strategy [23], spark retarding, EGR strategy [24] and using suitable bi-fuel catalyst converter [25]. However, these ways may have negative effects on other emissions.

Fig. 16 shows NO_x emissions for both CNG and gasoline fuels. As mentioned above, the NO_x emissions have direct relation to combustion chamber temperature. As shown in this figure, the NO_x emissions drop in higher loads for gasoline fuel. According to ECU strategy when engine load rises, more liquid fuel is injected into combustion chamber. Evaporation of this increased amount of liquid fuel reduces combustion chamber temperature and consequently NO_x emissions. Whereas, in the engine fuelled by CNG there is no cooling effect of fuel evaporation and NO_x emissions rise in higher loads. For both fuels, NO_x emissions grow at higher engine speeds because with increasing engine speed, combustion period is shortened and the O and N radicals don't have enough time to react.

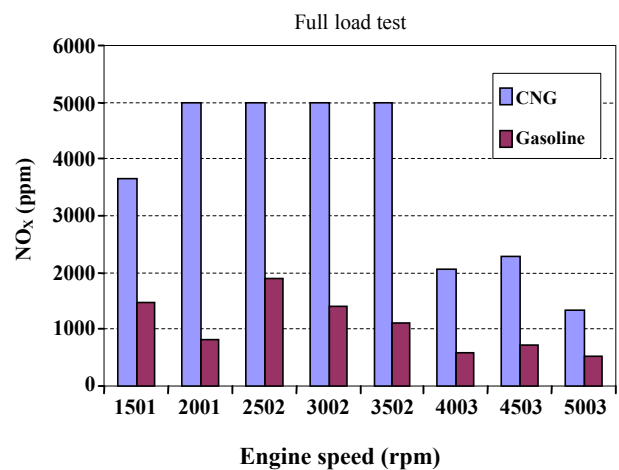
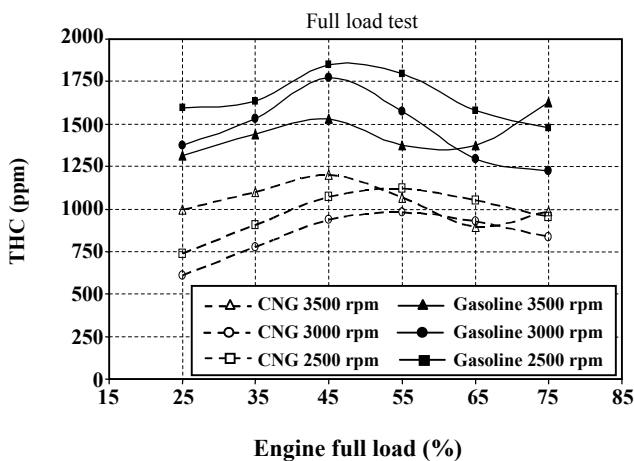
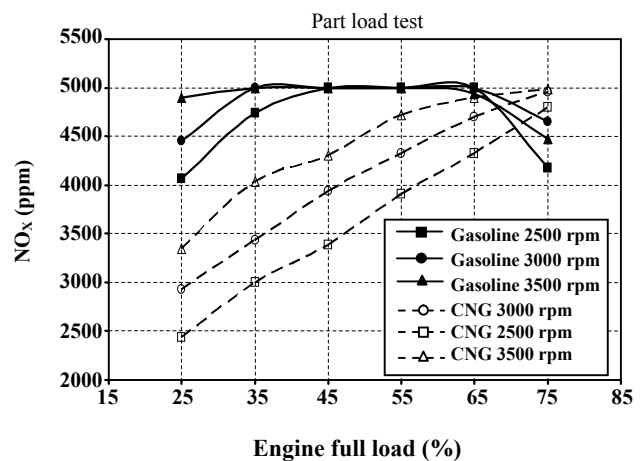
CONCLUSIONS

The object of these experiments was the study of performance and emissions characteristics of a Mazda B2000i bi-fuel (CNG + gasoline) SI engine. Individual engine tests have been done in steady state part load and full load conditions for CNG and gasoline fuels. All results have been measured before catalyst converter over a wide range of engine speeds. Engine operation with CNG has been compared with gasoline in full load condition and the following findings have been obtained:

1- At all engine speeds, volumetric efficiency decreased. The volumetric efficiency reduction was between 10 and 14.2 percent.

2- BMEP, torque and power decreased between 10.8 and 14 percent.

3- BSFC decreased in range of 15 and 24 percent. Thermal efficiency of CNG fuelled engine increased between 22 and 33 percent.

4- Emissions of CO and CO₂ are decreased. CO emissions decreased between 58 and 89 percent and the CO₂ between 0 and 11 percent.

5- The HC emissions demonstrate reduction between 37 and 58 percent.

6- The NO_x emissions are the only ones that show an increase in their amounts.

Nomenclatures

ANG	Adsorbed natural gas
BMEF	Brake mean effective pressure
BSFC	Brake specific fuel consumption
CFD	Computational fluid dynamics
CNG	Compressed natural gas
ECU	Electronic control unit
EGR	Exhaust gas recirculation
L	Litre
LNG	Liquefied natural gas
LPG	Liquid petroleum gas
MPa	Mega pascal
NO _x	Nitric oxides
OBD	On board diagnosis
SI	Spark ignition
THC	Total unburned hydrocarbons
WOT	Wide open throttling

Received : 19th December 2006 ; Accepted : 20th June 2007

REFERENCES

- [1] Shamekhi, A., Khatibzadeh, N., Shamekhi, A.H., Performance and Emissions Characteristics Investigation of a Bi-Fuel SI Engine Fuelled by CNG and Gasoline, Proceedings of ASME, Internal Combustion Engine Division, Paper No. ICES2006-1387 (2006).
- [2] Lapetz, J., McCarthy, D., Greenfield, N., Czapski, R., Geftos, T., Rosson, J., Development of the Ford QVM CNG Bi-Fuel 4.9L F-Series Pickup Truck, Society of Automotive Engineers, Paper No. 960850 (1996).
- [3] Duan, S.Y., Using Natural Gas in Engines: Laboratory Experience with the use of Natural Gas Fuel in IC Engines, IMechE Seminar Publication, pp. 39-46 (1996).
- [4] Johansson, B. and Olsson, K., Combustion Chambers for Natural Gas SI Engines, part 1: Fluid Flow and Combustion, Society of Automotive Engineers, Paper No. 950469 (1995).
- [5] Johansson, B. and Olsson, K., Combustion Chambers for Natural gas SI Engines, part 2: Fluid Flow and Combustion, Society of Automotive Engineers, Paper No. 950517 (1995).
- [6] Evans, R.L., Blaszczyk, J., Fast-Burn Combustion Chamber Design for Natural Gas Engines, ASME

- Journal of Engineering for Gas Turbines and Power*, **120** (1998).
- [7] Swain, M.R., Yusuf, M.J., Dulger, Z. and Swain, M.N., The Effect of Hydrogen Addition on Natural Gas Engine Operation, Society of Automotive Engineers, Paper No. 932775 (1993).
- [8] Zuo, C., Zhao, K. A., Quasi-dimensional Model of SI Natural Gas Engines with Pre-chamber, Society of Automotive Engineers, Paper No. 972994 (1997).
- [9] Evans, R. L., Blaszczyk, J. A., Comparative Study of The Performance and Exhaust Emissions of a Spark Ignition Engine Fuelled by Natural Gas and Gasoline, *Proc. Inst. Mech. Engrs.*, D00295 (1997).
- [10] Manivannan, A., Tamil Porai, P., Chandrasekaran, S., Ramprabhu, R., Lean Burn Natural Gas Spark Ignition Engines-An Overview, Society of Automotive Engineers, Paper Series 2003-01-0638 (2003).
- [11] Chiodi, M., Jurgen Berner, H., Baragende, M., Investigation on Mixture Formation and Combustion Process in a CNG Engine Using a Fast Response 3d cfd Simulation, Society of Automotive Engineers, Paper Series 2004-01-3004 (2004).
- [12] Shamekhi, A. H. and Ghaffari, A., An Improved Model for SI Engines, ASME Technical Conference, ICEF-2004-818 (2004).
- [13] Volpato, O., Theunissen, F., Mazara, R., Engine Management for Multifuel Plus Compressed Natural Gas Vehicles, Society of Automotive Engineers, Paper Series 2005-01-3777 (2005).
- [14] Aslam, M. U., Masjuki, H. H., Kalam, M. A., Abdessalam, H., Mahlia, T.M.I, Amalina, M.A., An Experimental Investigation of CNG as an Alternative Fuel for a Retrofitted Gasoline Vehicle, *Journal of fuel research*, Fuel **85**, p. 717 (2006).
- [15] Matranga, Kimberly R., Myers, Alan L., Glandt, Eduardo D., Storage of Natural Gas by Adsorption on Activated Carbon, *Chemical Engineering Sciences*, **47** (7), p. 1569 (1992).
- [16] Lozano-Castello, D., Alcaniz-Monge, J., Casa-Lillo, M. A., Cazorla-Amoros, D., Linares-Solano, A., Advances in the Study of Methane Storage in Porous Carbonaceous Materials, *Fuel*, **81**(14), p. 1777 (2002).
- [17] Pupier, O., Goetz, V., Fiscal, R., Effect of Cycling Operations on an Odsorped Natural Gas Storage, *Chemical Engineering and Processing*, **44** (1), p. 71 (2005).
- [18] Basumatary, R., Dutta, P., Prasad, M., Srinivasan, K., Thermal Modeling of Activated Carbon Based Adsorptive Natural Gas Storage System, *Carbon*, **43** (3), p. 541 (2005).
- [19] Heywood, J.B., "Internal Combustion Engine Fundamentals", McGraw-Hill Co. (1988).
- [20] Kato, K., Igrahashi, K., Masuda, M., Otsubo, K., Yasuda, A., Takeda, K. and sato, T., Development of Engine for Natural Gas Vehicle, Society of Automotive Engineers, Paper No. 01-0574 (1999).
- [21] Tilagone, R., Monnier, G., Chaouche, A., Baguelin, Y., Chauveron, D.S., Development of a High Efficiency, Low Emission SI-CNG Bus Engine, Society of Automotive Engineers, Paper No. 961080 (1996).
- [22] Kubesh, J. T., Igarashi, D. J., Guglielmo, K.H. and McaCaw, D., Development of an Electronically-Controlled Natural Gas-Fueled John Deere Power Tech 8.1L Engine, Society of Automotive engineers, Paper No. 951940, p. 788 (1995).
- [23] Goto, S., Itoh, Y., Higuchi, Y., NIGATA Ultra Lean Burn SI Gas Engines-Achieving High Efficiency and Low NO_x Emissions, Society of Automotive Engineers, Paper No. 901608 (1990).
- [24] Bhargava, S., Clark, N., Hildebrand, W., Exhaust Gas Recirculation in a Lean Burn Natural-Gas SI Engines, Society of Automotive Engineers, Paper No. 981385 (1998).
- [25] Chi-Burn, I., Sang-Ho, K., Catalyst Technology Satisfying Low Emissions of Natural Gas Vehicle, Society of Automotive engineers, Paper No. 970744 (1997).