

# Turbulent Events and Gas-Side Mass Transfer Coefficients in a Wavy Air-Water Stratified Flow

Nasr Esfahany, Mohsen\*<sup>+</sup>; Amanatchi, Nazi

Faculty of Chemical Engineering, Isfahan University of Technology, Isfahan, I.R. IRAN

**ABSTRACT:** Turbulence structure on the gas side of a wavy stratified flow was experimentally investigated in a near horizontal 18.7 cm (H) × 10 cm (W) × 5.5m (L) rectangular duct. By applying the Variable Interval Time Averaging (VITA) technique to the hot wire anemometer measurements frequency of occurrence of turbulent events were detected near the air-water interface. Experimental results showed that frequency of occurrence of turbulent events over the waves increased with the interfacial shear at the interface. Mass transfer coefficients were calculated making use of eddy cell model and calculated turbulent event frequencies. Predicted mass transfer coefficients show good agreement with experimental correlation. Conditional averages of turbulent events were obtained by applying VITA technique to the measured instantaneous velocities. Despite near wall region, both ejection and sweep can initiate turbulent event at the interface.

**KEY WORDS:** Turbulent flow, Turbulent event, Two phase flow, Stratified flow, Mass transfer

## INTRODUCTION

The local structure of turbulence at moving gas-liquid interfaces is an important factor in the transport of mass, momentum and energy between the gas and liquid phases in most two phase flows. An understanding of the mechanisms which create, convert and diffuse turbulence at moving interfaces is essential as a basis for more accurate mathematical modeling of the interfacial transport processes. The scalar transfer across a wavy sheared interface was investigated by *McCready & Hanratty* [1]; *Lim et al.* 1984[2]; *Kim et al.* 1985[3]; *Komori et al.* 1993[4], *Lorenz et al.* 1996[5].

*Komori et al.* experimentally investigated the mass transfer mechanism across a sheared air-water interface in terms of frequency and persistence of the organized motions in the interfacial region in a wind wave tank [4].

*Sakai et al.* [6] applied hot wire anemometry to measure

fluctuating mass fraction concentration and velocity in CO<sub>2</sub>-air mixtures. *Narayanan et al.* [7] explored the dynamics and control of large scale organized structures for a jet by using a single sensor hot film probe. *Klipp & Mahrt* [8] analyzed a convective Internal Boundary Layer (IBL) by focusing on the instantaneous structure of the top of the internal boundary layer instead of the time average structure. Conditional averaging technique was proposed to discriminate between the air from above the IBL and air from below the IBL. In most of the previous studies turbulence structure and mass transfer in liquid phase were investigated. This study is devoted to the investigation of the turbulence structure in the air stream flowing concurrent with a water flow in wavy stratified regime. Variable Interval Time Averaging Technique (VITA) is used to distinguish turbulent events and construct their structures.

\* To whom correspondence should be addressed.

+ E-mail: mnasr@cc.iut.ac.ir

1021-9986/11/2/91

9/\$/2.90

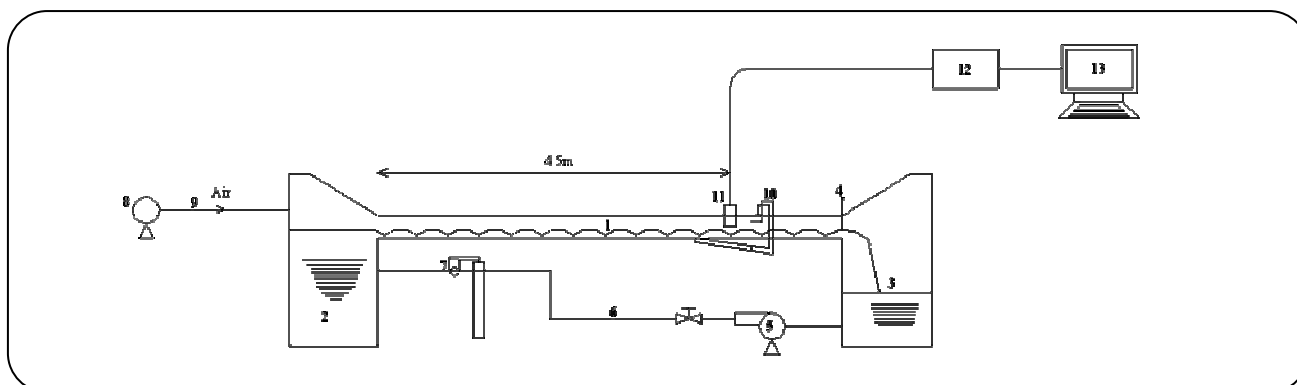

Fig. 1: Schematic diagram of experimental apparatus

## EXPERIMENTAL SECTION

Experiments were conducted using a two phase concurrent flow loop which included a rectangular flow channel (Fig. 1). The test channel was formed by a 5.5m long rectangular channel, 10 cm wide and 18.7 cm high. The working fluids were air and water and the experiments were conducted at near atmospheric pressure and room temperature.

A measurement station was located at the ceiling of the test channel at a distance,  $L=450$  cm, from the liquid inlet, which was considered to be sufficient to ensure fully developed flow. A single hot wire anemometer (Dantec 55p14) was used to measure the streamwise velocity component and to collect the data used later to detect the gas turbulent events. Hot wire anemometry is quite accurate for velocity measurements. The relative uncertainty in velocity measurements is reported to be less than 0.15% [9]. The probe was located at near interface over interfacial waves in gas phase. The output signal from this probe was sampled for a period of 90 seconds at a rate of 1 kHz. The wave characteristics such as frequency, velocity, length, and amplitude were measured using a video camera as explained in the next section. Table 1 shows the experimental condition for different runs. Wave characteristics are presented in Table 2.

### Wave characteristics

The wave characteristics such as frequency, wave amplitude, wavelength and wave speed were measured using a video camera (NV-VZ10EN). Horizontal and vertical rulers were placed on the test channel 4.5 m from the liquid inlet. In each experiment the waves were

recorded at the point where rulers were installed for a period of 1 to 2 minutes. The recorded data were transferred to a CD, so that the suitable software for determining wave characteristics could be used. Various softwares were searched and tested. Software Ulead Media Studio 6.5 was chosen which converted 1 second recorded movie into 26 frames. Wave frequency was measured by counting the number of waves passing a particular plane within 1 second. For determination of wave amplitude the recorded movie was observed frame by frame and wave amplitude was read by a vertical ruler which was installed on the side of the channel (for at least 20 waves). The wavelength was determined by measuring the distance between two consecutive troughs or crests by horizontally installed ruler (for at least 20 waves). Wave speed was calculated by dividing the distance the wave crest moves by time. Since movie was recorded in 26 frames per second, the time interval between two frames was 0.4 seconds.

Each experiment was repeated four times and the average wave characteristics were calculated and reported.

### VITA technique

To estimate the frequency of appearance of the organized motions near the gas-liquid interface, the well known VITA technique [10] was applied to the streamwise velocity signal in the air. In the VITA technique, the variable interval time average for a streamwise velocity  $u(t)$  at a particular position is defined by:

$$\hat{u}(t, T) = \frac{1}{T} \int_{t-\frac{T}{2}}^{t+\frac{T}{2}} u(s) ds \quad (1)$$

Table 1: The experimental matrix.

RUN	Average water depth (cm)	Water Reynolds Number	Air Reynolds Number
1	3	8280	56120
2	3	8280	24493
3	3	8280	44155
4	3	6979	56120
5	3	6979	24493
6	3	6979	44155
7	3	1899	44155
8	3	1899	56120
9	3	1899	24493
10	2	2067	23335
11	2	2067	44684
12	2	2067	55549
13	2	9009	55549
14	2	9009	44684
15	2	9009	23335
16	2	7452	23335
17	2	7452	44684
18	2	7452	55549
19	1	5067	58435
20	1	5067	43826
21	1	5067	20660
22	1	1602	20660
23	1	1602	43826
24	1	1602	58435

where  $T$  is the averaging time. A localized measure of the velocity intensity is represented by local variance:

$$\text{Var}(t, T) = u^2(t, T) - [\hat{u}(t, T)]^2 \quad (2)$$

Using this variance, a detection function of the organized motion is defined by:

$$D(t) = \begin{cases} 1 & \text{if } \text{var}(t, T) > k \cdot u_{\text{rms}}^2 \\ 0 & \text{otherwise} \end{cases} \quad (3)$$

where  $k$  is the threshold level and  $u_{\text{rms}}$  is the convectional r.m.s of the streamwise velocity fluctuation  $u(t)$ . The number of intervals in which  $D(t)=1$  gives

the number of appearance  $N_v$  of the organized motion then the frequency of appearance is obtained from:

$$f = \frac{N_v}{T_{\text{sampling}}} \quad (4)$$

In this work the dimensionless averaging time used was:

$$T^+ = Tu^{*2}/\nu \quad (5)$$

$$u^* = \sqrt{\frac{\tau_i}{\rho_G}} \quad (6)$$

$$\tau_i = \frac{1}{2} \rho_G f_i u_G^2 \quad (7)$$

Table 2: Characteristics of waves.

RUN	Frequency(1/s)	Amplitude(m×10 <sup>3</sup> )	Wave length(m×10 <sup>2</sup> )	Wave velocity (m/s×10 <sup>2</sup> )
1	5	3.5	7.0	50.3
2	8	2.4	5.5	35.7
3	5	5.2	7.5	53.1
4	5	4.9	8.3	50.0
5	8	2.7	5.0	40.0
6	4	6.5	8.5	55.8
7	4	5.5	11.2	49.6
8	5	4.0	10.0	41.6
9	6.5	2.3	4.6	29.0
10	6	2.5	6.0	32.3
11	5	4.5	8.5	40.5
12	5.5	3.7	6.3	36.8
13	7	5.0	7.0	49.0
14	6	5.5	8.2	52.9
15	9	1.8	5.2	41.6
16	9	1.8	5.2	40.8
17	6	5.3	6.8	47.6
18	8	3.8	6.1	43.3
19	8	1.4	3.5	42.7
20	7.5	1.2	4.2	48.3
21	-	-	-	-
22	-	-	-	-
23	6	2.4	4.0	36.6
24	9	2.4	3.0	35.0

Kowalski [11] made direct measurement of Reynolds shear stress in the gas for horizontal stratified flow. Interfacial stresses obtained by an extrapolation of the Reynolds stress profile to the interface were found to be 15-30 percent lower than those calculated from a momentum balance. Eqs. (8) and (9) were recommended for the interfacial friction factor for smooth and wavy interfaces, respectively.

$$f_i' = 0.96(\text{Re}_G)^{-0.52} \quad (8)$$

$$f_i = 7.5 \times 10^{-5} (1 - \alpha)^{-0.52} (\text{Re}_G)^{-0.52} \text{Re}_L^{0.83} \quad (9)$$

#### Averaging time

By considering  $k=2.7$  for run 2 conditional averages were calculated for two different averaging times. The results are shown in Fig. 2.  $\langle u' \rangle$  and  $\langle t \rangle$  are dimensionless velocity and time as defined in Eqs. (10) and (11), respectively. It is seen that turbulence structure is not a sharp function of averaging time therefore,  $T^+=15$  was used in this work.

$$\langle u' \rangle = \frac{u'}{u_*'} \quad (10)$$

$$\langle t \rangle = \frac{tu_*'^2}{\nu} \quad (11)$$

### The threshold level, $K$

It should be noted that different values of frequency can be obtained by choosing different values of the threshold level and therefore, the absolute value of frequency cannot be determined precisely with this technique.

The recommended value for the threshold level in liquid is 1 [10, 12]. Komori *et al.* (1993) [4] considered the threshold level where the profile of the number of appearances of the organized motions against the threshold level has a plateau ( $k=0.16$ ) however, this plateau was not seen in calculations for any of our experiments. Thus in this study a new method for determination of the threshold level is presented.

In each experiment instantaneous velocities were obtained by hot wire probe and saved in a file in computer. Then a file with random numbers with the same variance and average of the measured data was created (using MATLAB). By applying VITA technique to the generated file a threshold level was found by which the frequency of coherent structures calculated with VITA technique was zero. This threshold level was used for that specific run. By applying this method random turbulence noise was filtered from instantaneous velocity signal and just coherent structures were detected. In Table 3 values of the threshold level for each run are presented.

### Frequency of Turbulent events

Figs. 3, 4, and 5 show frequency of turbulent events versus interfacial velocity for water height of 3, 2, and 1 cm, respectively. Water flow rate was kept constant while different air flow rates were used. It can be seen from the figures that the frequency of the organized motion increases with the external shear at the interface. In runs 21 and 22 water-air interface was smooth and the frequency of the turbulent events was at a minimum. Therefore, waves seem to be responsible for the increasing frequency of the interfacial turbulent events. Interfacial shear is dominant parameter affecting the frequency of interfacial turbulent events in gas phase. The results show that the number of turbulent events increase with both the interfacial shear and the roughness of the interface. Interfacial turbulent events increase the mixing motion in the bulk of the gas and improve the scalar transport between two phases particularly if gas phase controls the mass transfer across the interface.

Table 3: Frequency of coherent structure and threshold level at each experiment.

RUN	Frequency of coherent structure(1/s)	Threshold level
1	17.3	2.9
2	14.5	2.7
3	16.2	2.9
4	17.5	2.9
5	14.2	2.7
6	14.5	2.9
7	11.7	2.6
8	15.3	2.8
9	10.3	1.9
10	9.3	1.9
11	12.9	2.6
12	13.9	2.9
13	18.7	2.9
14	17.5	2.8
15	13.9	2.7
16	14	2.5
17	14.8	2.8
18	18.9	2.9
19	20.4	2.9
20	17.9	2.8
21	9.5	2.1
22	9.9	2.0
23	14.0	2.5
24	15.41	2.7

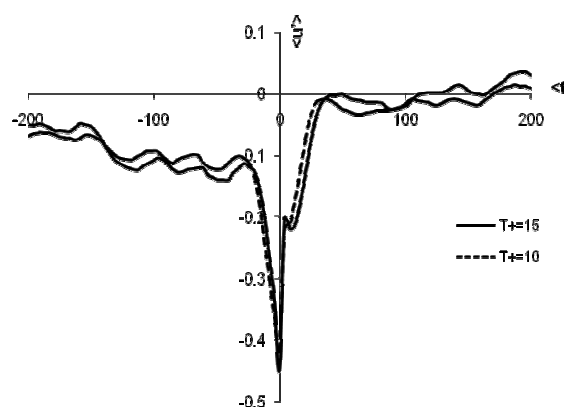

Fig. 2: Conditional averages for two different averaging times for run 2.

### Conditional averages of the turbulent events

Fig. 6 shows the conditional averages of  $u$  for all interfacial turbulent events for run 8. In Figs. 7 and 8 two kinds of events are separated:

1- events with positive slope  $\left(\frac{du}{dt} > 0\right)$

2- events with negative slope  $\left(\frac{du}{dt} < 0\right)$

Conditional average for the events with positive slope (Fig. 7) indicates that a low speed parcel of fluid moves away from the interface towards the bulk of the flowing air (ejection) followed by a high speed parcel of fluid from the bulk of the air approaching the interface (sweep). Between the ejection of the low speed fluid and sweep of the high speed fluid, there is a significant change in streamwise velocity. Conditional average for negative slope events (Fig. 8) indicates a parcel of high speed fluid approaches the interface followed by a low speed fluid moving away from the interface. The results show that at the interface both ejection and sweep can initiate the turbulent event. In opposite at the wall almost all of the time ejection initiates the turbulent event.

### Prediction of mass transfer coefficients

Komori *et al.* 1993[4] proposed a hybrid surface renewal eddy cell model to explain their  $\text{CO}_2$  absorption experiments in a wind wave tank. The eddy cell model in gas phase was adopted in this work to predict the mass transfer coefficients across the interface. Following the method proposed by Komori *et al.* [4], gas side mass transfer coefficient is obtained by solving the diffusion equation for the eddy cell as shown in Eq. (12).

$$k_g = 0.9(D_g \cdot f_g)^{\frac{1}{2}} \quad (12)$$

Mass transfer coefficients were calculated for each run making use of the Eq. (12). Fig. 9 shows comparison between the predictions from Eq. (12) (used to calculate Sherwood number) with the values obtained from the empirical correlation ( $J_D = 0.11 \text{Re}^{-0.29}$ ) [13]. Fig. 9 shows that mass transfer coefficients calculated from Eq. (12) are in relatively good agreement with the empirical correlation. The average error between the calculated and empirical Sherwood numbers is less than thirty five percent which is acceptable considering the large error margin of

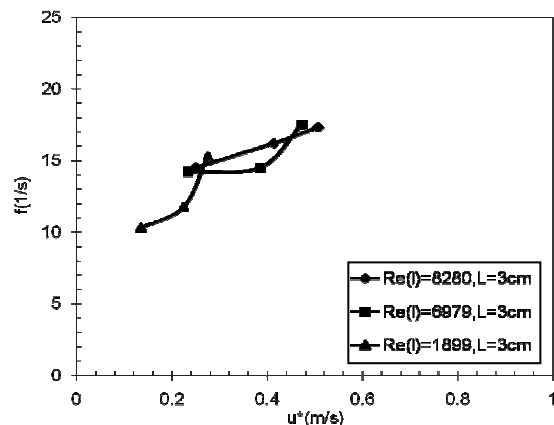

Fig. 3: Frequency of turbulent events versus interfacial velocity (water height=3 cm).

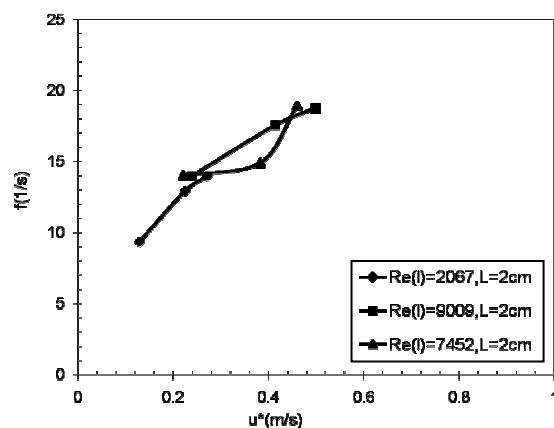

Fig. 4: Frequency of turbulent events versus interfacial velocity (water height=2 cm).

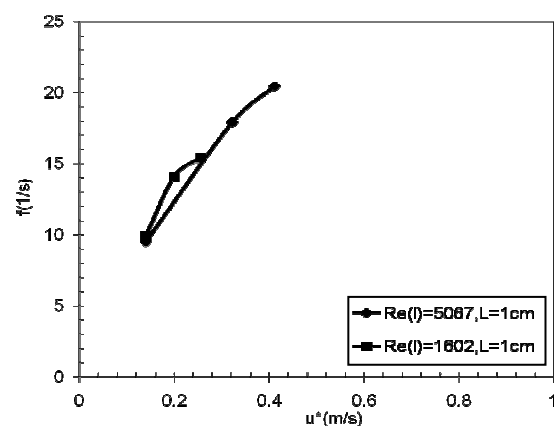

Fig. 5: Frequency of turbulent events versus interfacial velocity (water height=1 cm).

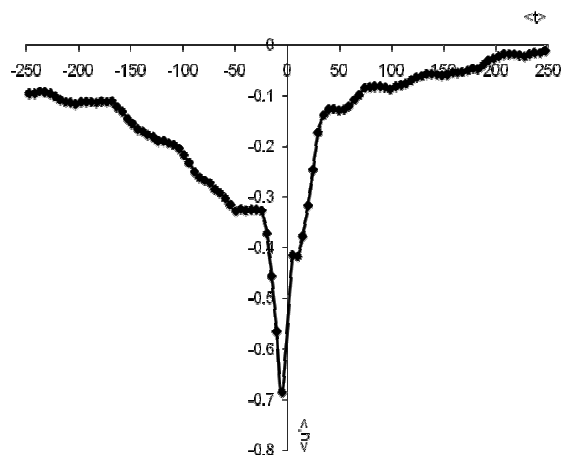

Fig. 6: Conditional average for run 8 (all events).

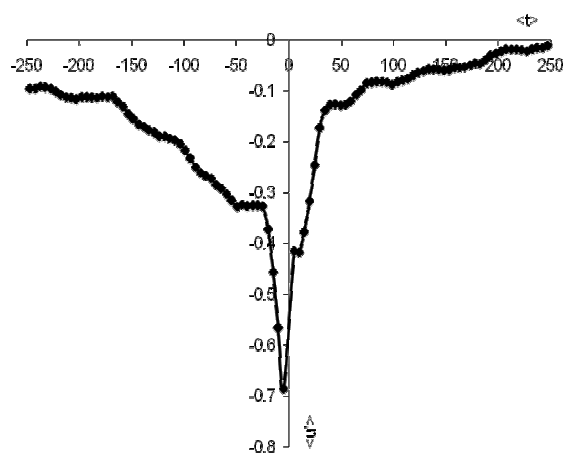

Fig. 7: Conditional average for run 8 (positive slope events).

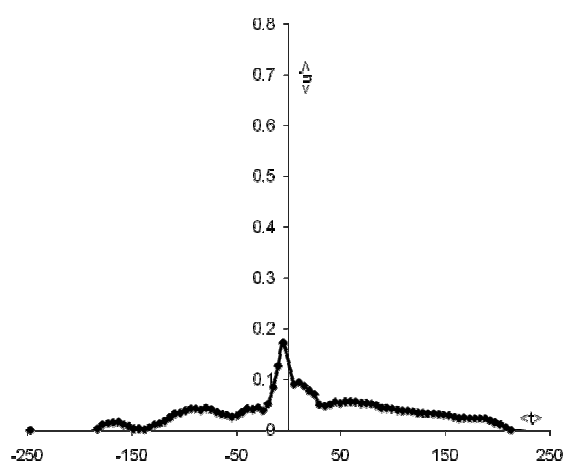

Fig. 8: Conditional average for run 8 (negative slope events).

empirical correlations. Good agreement between calculated and empirical Sherwood numbers emphasizes that turbulent events are responsible for the mass transfer at the interface.

#### Mass transfer and turbulence structure

Gas side mass transfer coefficients were calculated by making use of the frequency of the turbulent events for each run. Figs. 10, 11 and 12 show mass transfer coefficient versus interfacial velocity. Water flow rate was kept constant for different air flow rates. Figures indicate that by increasing the interfacial velocity and roughness at the interface, the mass transfer coefficient increases. This increase is due to the increase of the frequency of appearance of the organized motions above the liquid interface. Results show that waves and shear are important parameters affecting mass transfer coefficients. In runs 21, 22 surface of liquid is smooth and mass transfer coefficients are at their lowest value.

#### CONCLUSIONS

The structure of turbulence over the gas-liquid interface in stratified co current flow of air and water in a rectangular channel has been investigated experimentally in connection with the interfacial transfer of mass. Hot wire anemometry and VITA technique were used to investigate the frequencies of the organized motions occurring over the wavy interface. The main result from this study can be summarized as follows:

- 1- A new method for detecting the threshold level in VITA technique is presented.
- 2- Averaging time in VITA technique does not show much effect on calculated frequencies.
- 3- With increasing gas velocity and external shear at the interface the number of coherent structures increases.
- 4- At gas-liquid interface both ejection and sweep initiate turbulent.
- 5- The mass transfer coefficients can be estimated by eddy cell model.
- 6- By increasing the interfacial velocity at constant water depth and water flow rate, gas side mass transfer coefficient increases.

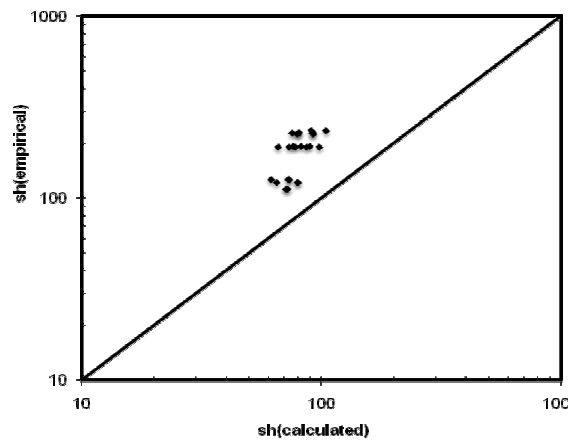

Fig. 9: Comparison of Experimental and predicted Sherwood numbers (equation 12).

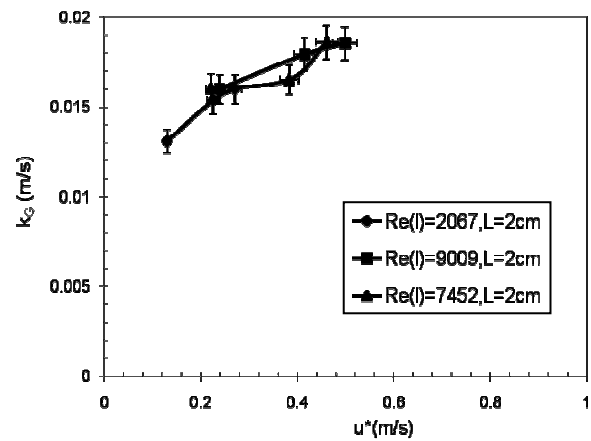

Fig. 11: Mass transfer coefficient versus interfacial velocity (water height=3 cm).

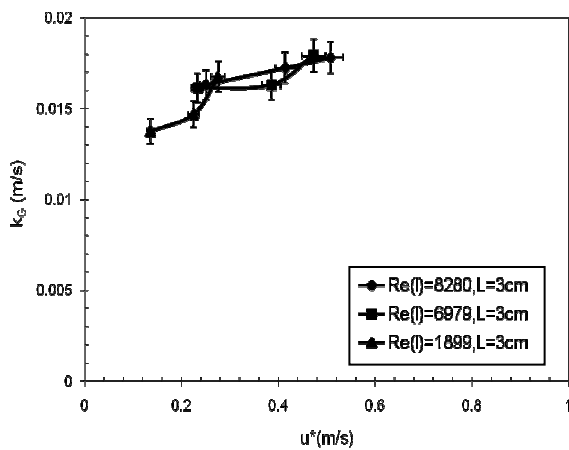

Fig. 10: Mass transfer coefficient versus interfacial velocity (water height=3 cm)

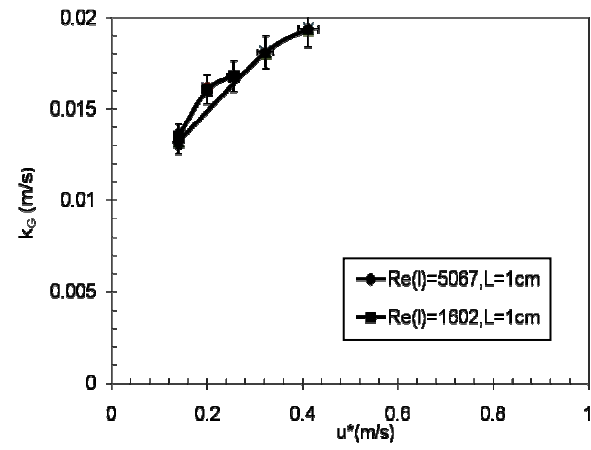

Fig. 12: Mass transfer coefficient versus interfacial velocity (water height=3 cm)

**Nomenclature**

$D_g$	Molecular diffusivity of gas, $m^2/s$
$D(t)$	Detection function
$f_g$ or $f$	Frequency of organized motions, $1/s$
$f_i$	Interfacial friction factor
$H$	Total channel height, cm
$J_D$	Mass transfer coefficient
$k$	Threshold level
$k_g$	Mass transfer velocity, $m/s$
$L$	Total channel length, m
$N_v$	number of appearance of the organized motions
$Re_G$	Gas Reynolds number
$Re_L$	Liquid Reynolds number
$Sh$	Sherwood number
$T$	Integration time for VITA

$T^+$	Dimensionless integration time for VITA
$T_{sampling}$	Sampling time by sensor
$u(t, T)$ or $u(t)$	Streamwise velocity
$\hat{u}(t, T)$	Mean streamwise velocity
$u_{rms}$	Conventional rms of streamwise velocity
$u_G$	Gas velocity
$u^*$	Interfacial friction velocity
$Var$	Variance
$W$	Total channel width, cm
$\alpha$	Gas volume fraction
$\nu$	Gas kinematic viscosity
$\tau_i$	Interfacial shear stress
$\rho_G$	Gas density

Received : Dec. 22, 2009 ; Accepted : May 23, 2011



## REFERENCES

- [1] McCready M.J., Hanratty T.J., Effect of Air Shear on Gas Absorption by a Liquid Film, *AIChE J.*, **31**(12), p. 2006 (1985).
- [2] Lim I.S., Tankin R.S., Yuen M.C., Condensation Measurements of Horizontal Cocurrent Stream/Water Flow, *ASME J.Heat Transf.*, **106**, p. 425, (1984).
- [3] Kim H.J., Lee S.C., Bankoff S.G., Heat Transfer and Interfacial Drag in Counter Current Steam-Water Stratified, *Int. j. Multi Phase Flow*, **11**(5), p. 593, (1985).
- [4] Komori S., Nagaosa R., Murakami Y., Turbulence Structure and Mass Transfer Across a Sheared Air-Water Interface in Wind-Driven Turbulence, *J.Fluid Mech*, **249**, p. 161 (1993).
- [5] Lorencez C., Nasr-Esfahany M., Kawaji M., Ojha M., Liquid Turbulence Structure at a Sheared and Wavy Gas-Liquid Interface, *Int.J.Multiphase Flow*, **23**(2), p. 205 (1997).
- [6] Sakai Y., Watanabe T., Kamoara S., Kushida T., Nakamura I., Simultaneous Measurements of Concentration and Velocity in a CO<sub>2</sub> Jet Issuing into a Grid Turbulence by Two Sensor Hot Wire Probe, *Int. J. of Heat and Fluid Flow*, **22**, p. 227 (2001).
- [7] Narayanan S., Barooah P., Cohen J.M., "Experimental Study of the Coherent Structure Dynamics and Control of an Isolated Jet in Cross Flow", 40<sup>th</sup> Aerospace Science Meeting and Exhibit, United Technologies Research Center, January 14-17, (2002).
- [8] Klipp C., Mahrt L., Conditional Analysis of an Internal Boundary Layer, *Boundary Layer Meteorology*, **108**, p. 1 (2003).
- [9] Bruun H.H., "Hot Wire Anemometry, Principles and Signal Analysis", Oxford University Press, Oxford, New York, , pp. 99 (1996).
- [10] Blackwelder R.F., Kaplan R.E., On the Wall Structure of the Turbulent Boundary Layer, *J. Fluid Mech*, **76**, p. 89 (1976).
- [11] Kowalski J.E., "Wall and Interfacial Shear Stress in Stratified Flow in a Horizontal Pipe", *AIChE Ann. Meet.*, San Francisco, (1984).
- [12] Lorencez C., Nasr-Esfahany M., Kawaji M., "Investigation of Turbulence Structure and Prediction of Interfacial Heat and Mass Transfer in Wavy Stratified Flow", *AIChE J.*, **43**, p. 1426 (1997).
- [13] Treybal R., "Mass Transfer Operations", 3<sup>rd</sup>. ed., McGraw-Hill Inc, Singapore, (1980).