

# Feasibility Study of Integrating Multi Effect Desalination and Gas Turbine Systems for Lavan Island Oil Refinery

**Shakouri, Mahdi<sup>\*+</sup>**

*Young Researchers Club, Science and Research Branch, Islamic Azad University, Tehran, I.R. IRAN*

**Ghadamian, Hossein**

*Department of Energy Engineering, Science and Research Branch, Islamic Azad University, Tehran, I.R. IRAN*

**Mohammadpour Bagheri, Farzaneh**

*Department of Medical Engineering, Science and Research Branch, Islamic Azad University, Tehran, I.R. IRAN*

**ABSTRACT:** *In this research, feasibility study of integrating thermal desalination unit with Gas Turbine (GT) has been investigated using retrofit and grass root design techniques for Lavan Island Oil Refinery which is located in Persian Gulf. According to computed parameters on developed code for the power generation unit No.1 using EES (Engineering Equation Solver) software, thermal efficiency of the GT unit No.1 and thermal energy recovered by HRSG (Heat Recovery Steam Generator) are equal to 22.79% and 4847 kW, respectively. Therefore, it shows a considerable potential on heat recovery and motive steam production. Effect of variations on different quantitative and qualitative parameters has been reviewed on the next step of this research. Finally, effect of engineering and economical parameters has been compared based on the following scenarios:*

- *Integrating available Thermal Desalination Unit (TDU) with available steam boiler,*
- *Retrofitting available TDU with HRSG,*
- *Integrating GT unit No.1 with novel simulated TDU based of grass root design.*

*As a result, based on economical model, which has been developed using GAMS (Generalized Algebraic Modelling System) software, the selected scenario is the third scenario.*

**KEY WORDS:** *Multi effect desalination; Gas turbine unit; Heat recovery steam generator; Dual-purpose system.*

## INTRODUCTION

Producing fresh water using flue gas recovery of the gas turbine in dual-purpose system is more pay attentions in recent years. Boiler elimination for desalination process and reducing among 60 to 70% in fuel consumption are

two major finding terms should be considered because of using dual-purpose system [1]. By these clarifications, water production cost will be more economical.

Lavan Island is a coral, and its existence relates to

---

*\* To whom correspondence should be addressed.*

*+ E-mail: m.shakouri@srbiau.ac.ir*

*• Other Address: Department of Energy Engineering, Science and Research Branch, Islamic Azad University, Tehran, I.R. IRAN  
1021-9986/12/3/115 10/\$/3.00*

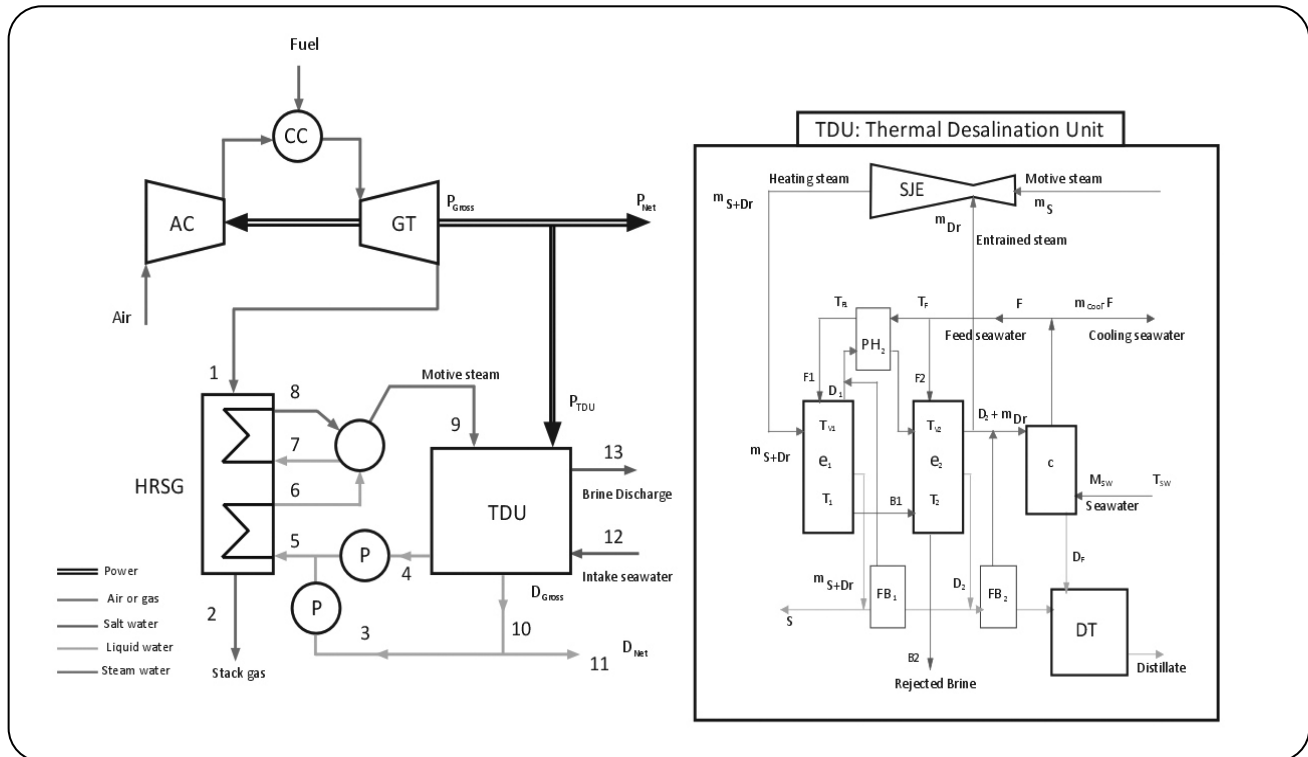

Fig. 1: Dual-purpose system schematic.

the fourth period of geology. It is located in Persian Gulf and within 16 km of the southern coast of Iran in  $53^\circ$  latitude and  $26^\circ$  plus 50 min longitude. Summer temperature of the island is among 37 to 45  $^\circ\text{C}$  and in winter the temperature is among 10 to 25  $^\circ\text{C}$ . There are three gas turbine units (type Alstom TB 5000) in Lavan Island Oil Refinery [2]. Based on 13.676 MW input heat (with gasoline fuel) and 3.117 MW power generations at the ambient temperature equal to 23.6  $^\circ\text{C}$ , thermal efficiency of the gas turbine unit No. 1 is equal to 22.79%.

In previous research retrofitting motive steam generation by Heat Recovery Steam Generator (HRSG) for the power generation unit No. 2 of Lavan Island has been investigated [2]. But in this research, an optimization model has been developed for Multi Effect Thermal Vapour Compression (METVC) desalination unit based on three scenarios for the power generation unit No. 1. Three considered scenarios for the purpose of this research are including:

- Integrating available TDU with available steam boiler
- Retrofitting available TDU with HRSG
- Integrating GT unit No.1 with novel simulated TDU based of grass root design

To achieve the minimum total cost for three scenarios, a dual-purpose system has been simulated using EES software [3], and therefore the model is been optimized in GAMS software [4]. It should be mentioned; in this research the parametric study on key performance indicators on dual-purpose system for each scenario has been added to research topics to cover the aim of simulation results.

## THEORETICAL AND EXPERIMENTAL SECTION

In Fig. 1 a schematic for power production unit, heat recovery steam generator and desalination system is illustrated. The Steam Jet Ejector (SJE) runs by the motive steam. The heating steam, which produced in steam jet ejector, provides energy for seawater evaporation during condensation in the first evaporator. Part of the condensate returns to the HRSG, and remain part is introduced into the associated flashing box. During this procedure, pressure drop causes small amount of vapour flash-off. The evaporated seawater in the first evaporator passes to preheat the feed seawater. Then it routed into the second effect together with the flashing vapour and served as the heat source in the second evaporator. The balanced brine flowed into the second effect and

produced vapour by flashing. Part of the heated seawater used as the feed of the second effect TVC unit, and the balance rejected back to the sea [1].

#### Optimization model for integrating dual-purpose system

Equations applied in optimization model are been tabulated in Table 1. Firstly, to compare the scenarios based on thermodynamic viewpoint, the model has been simulated using EES software. As it presented in Table 2, the flue gases test run done for estimating the amount of heat recovery potential. According to the analysis based on molar mass, flue gas components are as follows:

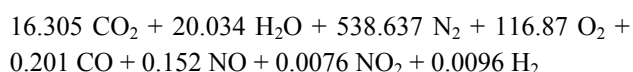

The enthalpy of flue gas at HRSG entrance is equal to 377.49 kJ/kg, considering the temperature and pressure equal to 656.5 K and 105 kPa, respectively at that point. In addition, the enthalpy at HRSG exit is equal to 134.15 kJ/kg, assuming the temperature and pressure equal to 428.1 K and 102 kPa, respectively (considering acid dew point constraint). As a result, the thermal energy recovered by HRSG is equal to 4846.72 kW.

To cover the feasibility study of seven tons per hour boiler substitution with HRSG for the second and third scenarios, a separate code has been developed using EES software. Related conditions of steam production and fuel consumption for the available steam boiler presented in Table 3. Input and concluded values for simulation of three scenarios have been tabulated in Table 4.

On the second step of simulation, variations of some quantitative and qualitative parameters are been investigated for each scenario. Main characteristics, which selected for parametric study in this research, are as follows:

- Gain Output Ratio (GOR),
- Temperature difference between effects ( $\Delta T$ ),
- Concentration ratio ( $X_{br}/X_{sw}$ ),
- Total exergy destruction ( $\sigma T_{o \text{ tot}}$ ),
- Specific heat transfer area (a).

#### Economical optimization model for total cost

In order to exclude minimum total cost, a thermo-economical model has been developed using GAMS software. The annual capital cost can classify as direct ( $C_d$ ) and indirect ( $C_i$ ) costs. To calculate the annual cost, the capital cost must depreciate. Where in this research,

the amount of interest rate (i) and plant life cycle (n) assumed equal to 15% and 20 years, respectively.

Direct capital costs include the major and auxiliary equipment ( $C_{eq}$ ), land ( $C_l$ ) and site development ( $C_{sd}$ ) costs. Because of land availability, the term of  $C_l$  assumed zero. In this study 90/10 Cu-Ni alloy is used as heat surface material, which base price is assumed 195  $\$/\text{m}^2$  and represents about 25% of the plant capital cost. The indirect capital cost includes freight cost ( $C_{fr}$ ), construction overhead cost ( $C_{co}$ ), owner's costs ( $C_{ow}$ ) and contingency cost ( $C_{em}$ ) which formulated in Table 1.

Annual operating costs are those expenditures acquired, after plant commissioning and during actual operation. Operating cost includes pumping ( $C_p$ ), labor ( $C_{lb}$ ), chemicals ( $C_{ch}$ ), maintenance and spare parts ( $C_m$ ), insurance ( $C_{in}$ ), thermal energy cost ( $C_T$ ) and exergy lost opportunity costs ( $C_{\sigma T_o}$ ) [2]. Labor costs depend on the plant ownership whether is public or private. Maintenance and spare part cost ( $C_m$ ) and insurance cost ( $C_{in}$ ) can be estimated as 2% and 0.5% of the total annual capital cost, respectively [9]. In this research, value of the electricity costs ( $C_{el}$ ), the specific cost of operating labor ( $\alpha$ ) and the specific chemical cost (k) assumed equal to 0.07  $\$/\text{kWh}$ , 0.1  $\$/\text{m}^3$  and 0.04  $\$/\text{m}^3$ , respectively. The energy costs invariably representing among 50-75% of real desalination operating costs [9]. The medium pressure steam production cost by HRSG ( $C_s$ ) is approximately equal to 0.03  $\$/\text{ton}$  based on 2011 year prices. The annual HRSG steam production cost can calculate from Eq. (43), which should added to annual cost for the second and third scenarios.

If the plant assumed to operate 330 days during a year to allow time for preventive maintenance and unforeseen shutdowns, the plant load factor will be 0.9. For optimizing this model motive steam is supposed to be constant and avoidable exergy destruction coefficient for exergy opportunity cost assumed equal to 0.1.

## RESULTS AND DISCUSSIONS

### Variation of Gain output ratio and Concentration ratio with $\Delta T$

Variations of concentration ratio ( $X_{br}/X_{sw}$ ) and changes of GOR in different temperatures between effects have been examined based on the quantitative and qualitative viewpoint. The obtained graphs for mentioned scenarios illustrated in Figs. 2, 3 and 4, respectively.

Table 1: Equations applied for optimization model.

Terms and Descriptions	Equation	
Gain Output Ratio (GOR) [2]	$GOR = \frac{D}{m_s}$	(1)
Specific heat transfer area, (m <sup>2</sup> .s/kg) [2]	$a = \frac{A}{D}$	(2)
Thermal efficiency of the cycle [2]	$\eta_t = \frac{P}{Q_f} = \frac{P}{m_f \cdot LHV}$	(3)
Power-to-water ratio, (kW.s/kg) [2]	$R_{pw} = \frac{P}{D}$	(4)
Temperature difference across each effect, (K) [5]	$T_1 - T_2 = T_2 - T_3 = \dots = T_n - T_{n-1} = \Delta T$	(5)
Equal specific heat capacity for the feed seawater to that of the brine and distillate water, (kJ/kg.K) [5]	$SHC_F = SHC_D = SHC_B = SHC$	(6)
Equal feed flow rate in all effects (parallel feed arrangement), (kg/s) [5]	$F_1 = F_2 = F_3 = \dots = F_n = \frac{F}{n}$	(7)
Equal boiling point elevation for all effects, (K) [5]	$BPE = T_i - T_{vi} = 0.8$	(8)
Equal temperature increase across the feed heaters, (K) [5]	$T_{f1} - T_{f2} = \dots = T_{fn-1} - T_{fn} = \Delta T$	(9)
Mass balance of effects, (kg/s) [6]	$F_i + B_{i-1} = D_i + B_i$	(10)
Concentration balance of effects, (ppm) [6]	$X_{F_i} \cdot F_i + X_{B_{i-1}} \cdot B_{i-1} = X_{B_i} \cdot B_i$	(11)
Energy balance of effects, (kW) [6]	$D_n \cdot L_n = \left[ D_{n-1} + \sum_{i=1}^{n-2} (D_i + D_i) \cdot y - (n-1) \times F_n \right] \cdot L_{n-1} - F \cdot SHC \cdot (T_n - T_f) + B_{n-1} \cdot SHC \cdot \Delta T$	(12)
Heat-transfer coefficient of evaporation, (kW/m <sup>2</sup> .K) [7]	$U_e = 1.9394 + 1.40562 \times 10^{-3} \times T_e - 2.07525 \times 10^{-5} \times T_e^2 + 2.3186 \times 10^{-6} \times T_e^3$	(13)
Heat-transfer coefficient of condensation, (kW/m <sup>2</sup> .K) [7]	$U_c = 1.6175 + 1.537 \times 10^{-4} \times T_c - 1.825 \times 10^{-4} \times T_c^2 + 8.026 \times 10^{-8} \times T_c^3$	(14)
Heat-transfer coefficient of preheating, (kW/m <sup>2</sup> .K) [7]	$U_{ph} = 14.18251642 + 0.011383865 \times T_{v_n} + 0.013381501 \times T_{E_{n-1}}$	(15)
Heat transfer area of evaporation effects, (m <sup>2</sup> ) [5]	$A_{e_n} = \frac{[(D_{n-1} + \dots + D_{n-2} + D_f) \cdot y - (n-1) \cdot y \cdot F_n] \cdot L_{n-1}}{U_{e_n} \cdot (T_{v_{n-1}} - T_n)}$	(16)
Heat transfer area of condenser, (m <sup>2</sup> ) [5]	$A_c = \frac{[D_f + (D_f \cdot D_1 + \dots + D_{n-1}) \cdot y] \cdot L_n}{U_c \cdot (LMTD)_c}$	(17)
Heat transfer area of preheaters, (m <sup>2</sup> ) [5]	$A_{ph_n} = \frac{n \cdot F_n \cdot (T_{f_n} - T_{f_{n-1}})}{U_{h_n} \cdot (LMTD)_{h_n}}$	(18)
Exergy destruction of steam jet ejector, (kW) [8]	$\sigma T_{o\_SJE} = m_s \cdot [(h_s - h_{v_{hs}}) - T_o \cdot (s_s - s_{v_{hs}})] - D_f \cdot [(h_{v_{hs}} - h_{v_n}) - T_o \cdot (s_{v_{hs}} - s_{v_n})]$	(19)
Exergy destruction of desalting effects, (kW) [5]	$\sigma T_{o\_e_n} = [D_{n-1} + (D_1 + \dots + D_{n-2} + D_f) \cdot y - (n-1) \cdot F_n \cdot y] \cdot L_{n-1} \cdot \left(1 - \frac{T_o}{T_{v_1}}\right) + B_{n-1} \cdot SHC \cdot \left[\Delta T - T_o \cdot \ln\left(\frac{T_{n-1}}{T_n}\right)\right] - D_n \cdot L_n \cdot \left(1 - \frac{T_o}{T_n}\right) - F_n \cdot SHC \cdot \left[(T_n - T_{f_n}) - T_o \cdot \ln\left(\frac{T_n}{T_{f_n}}\right)\right]$	(20)

Table 1: Continued

Exergy destruction of Condenser, (kW) [5]	$\sigma T_{oc} = [D_f + (D_r + D_1 + \dots + D_{n-1})y] \cdot L_n \cdot \left(1 - \frac{T_o}{T_n}\right) - m_c \cdot \text{SHC} \cdot \left[ (T_r - T_c) - T_o \cdot \ln\left(\frac{T_r}{T_c}\right) \right]$	(21)
Exergy destruction of entrained steam, (kW) [8]	$\sigma T_{oD_r} = D_r \cdot \text{SHC} \cdot \left[ (T_{v_e} - T_c) - T_o \cdot \ln\left(\frac{T_{v_e}}{T_c}\right) \right]$	(22)
Exergy destruction of condenser distillate, (kW) [8]	$\sigma T_{oD_r} = D_r \cdot \text{SHC} \cdot \left[ (T_{v_e} - T_c) - T_o \cdot \ln\left(\frac{T_{v_e}}{T_c}\right) \right]$	(23)
Exergy destruction of rejected brine, (kW) [8]	$\sigma T_{oB_n} = B_n \cdot \text{SHC} \cdot \left[ (T_n - T_c) - T_o \cdot \ln\left(\frac{T_n}{T_c}\right) \right]$	(24)
Equipment cost, (\$) [9]	$C_{eq} = 4 \times C_{at}$	(25)
Side development cost, (\$) [9]	$C_{sd} = 0.2 \times C_{eq}$	(26)
Land cost, (\$) [2]	$C_l = 0$	(27)
Direct capital cost, (\$)	$C_d = C_{eq} + C_{sd} + C_l$	(28)
Freight cost, (\$) [9]	$C_{fr} = 0.05 \times C_d$	(29)
Construction overhead cost, (\$) [9]	$C_{co} = 0.15 \times C_{eq}$	(30)
Owners cost, (\$) [9]	$C_{ow} = 0.1 \times C_{eq}$	(31)
Contingency cost, (\$) [9]	$C_{em} = 0.1 \times C_d$	(32)
Indirect capital cost, (\$)	$C_i = C_{fr} + C_{co} + C_{ow} + C_{em}$	(33)
Depreciation factor	$Z = \left[ \frac{i(i+1)^n}{(i+1)^n} - 1 \right]$	(34)
Annual capital cost, (\$/yr) [9]	$C_{ac} = Z \times (C_d + C_i)$	(35)
Pumping cost, (\$/yr) [9]	$C_p = E_p \times C_{el} \times 24 \times f \times 365$	(36)
Labor cost, (\$/yr) [9]	$C_{lb} = \alpha \times D_{an} \times f \times 365$	(37)
Chemical cost, (\$/yr) [9]	$C_{ch} = k \times D_{an} \times f \times 365$	(38)
Maintenance and spare parts cost, (\$/yr) [9]	$C_m = 0.02 \times C_{ac}$	(39)
Insurance cost, (\$/yr) [9]	$C_{in} = 0.005 \times C_{ac}$	(40)
Exergy lost opportunity cost, (\$/yr) [2]	$C_{\sigma To} = \beta \times \sigma T_{o SJE} \times C_{el} \times 24 \times f \times 365$	(41)
Thermal energy cost, (\$/yr) [9]	$C_T = \left( \frac{C_f \times m_f \times 24 \times 3600}{\text{Specific fuel weight}} \right) \times f \times 365$	(42)
Annual HRSG steam production cost, (\$/yr)	$C_{aS} = C_S \times m_S \times 24 \times 3600 \times f \times 365$	(43)
Annual operating cost, (\$/yr)	$C_{op} = C_p + C_{lb} + C_{ch} + C_m + C_{in} + C_{\sigma To} + C_T + C_{aS}$	(44)
Annual cost, (\$/yr)	$C_{an} = C_{ac} + C_{op}$	(45)
Optimization objective function, (\$/m <sup>3</sup> )	Minimizing unit product cost (UPC = $\frac{C_{ac} + C_{op}}{D_{an}}$ )	(46)

**Table 2: Lavan Island Oil Refinery, GT unit No. 1 flue gas analysis test-run conclusions.**

Parameter	Value	Parameter	Value
O <sub>2</sub> (%)	17.7	Air (%)	540.1
CO <sub>2</sub> (%)	2.47	Gas Temperature (K)	656.5
CO (ppm)	293.4	Air Temperature (K)	296.6
NO (ppm)	221.43	Mass flow rate (kg/s)	19.92
NO <sub>2</sub> (ppm)	11.07	Thermal efficiency (%)	22.79
H <sub>2</sub> (ppm)	14		

**Table 3: Lavan Island Oil Refinery, boiler fuel consumption and steam production.**

Parameter	Value	Parameter	Value
Produced motive steam (kg/s)	1.944	Low heat value of gas fuel (kJ/kg)	45700
Pressure of motive steam (MPa)	1.034	Specific fuel weight (kg/Nm <sup>3</sup> )	2.495
Enthalpy of motive steam (kJ/kg)	2779	Fuel consumption (kg/s)	0.1285
Boiler efficiency (at 100% load)	0.92	Fuel price (2011 year) (\$/m <sup>3</sup> )	0.171

**Table 4: I/O values for three scenarios simulation.**

Descriptions	Scenario 1	Scenario 2	Scenario 3
Inputs			
Temperature difference between effects, $\Delta T$ (K)	15.6	15.6	9.7
Salinity of seawater, $X_{sw}$ (ppm)	50000	50000	50000
Salinity of rejected brine, $X_{br}$ (ppm)	64300	64300	64300
Seawater temperature, $T_{sw}$ (K)	305.1	305.1	305.1
Motive steam pressure, $P_S$ (MPa)	1.034	2.845	1.034
Outputs			
Mass flow rate of distillate water, $D$ (kg/s)	2.769	2.769	2.627
Mass flow rate of seawater, $m_{sw}$ (kg/s)	32.717	32.717	26.741
Mass flow rate of cooling water, $m_{cool}$ (kg/s)	19.426	19.426	14.445
Mass flow rate of motive steam, $m_S$ (kg/s)	0.891	0.891	0.891
Mass flow rate of feed seawater, $F$ (kg/s)	13.291	13.291	12.296
Mass flow rate of brine blow down, $B$ (kg/s)	15.505	15.505	14.29
Gain Output Ratio, $GOR$	3.108	3.108	2.948
Pumping power, $E_P$ (kW)	45.3	45.3	42.96
Total heat transfer area, $A_{tot}$ (m <sup>2</sup> )	363.29	363.25	387.85
Specific heat transfer area, $a$ (m <sup>2</sup> .s/kg)	131.19	131.184	147.621
Thermal efficiency of GT cycle, $\eta_t$ (%)	-	22.79	22.79
Gross Power produced by GT (kW)	-	3117	3117
Power to water ratio, $R_{pw}$ (kJ/kg)	-	1125.677	1186.524
Exergy destruction of steam jet ejector, $\sigma T_{o SJE}$ (kW)	220.46	318	241.36
Total exergy destruction of TDU, $\sigma T_{o tot}$ (kW)	546.7	644.2	529.6

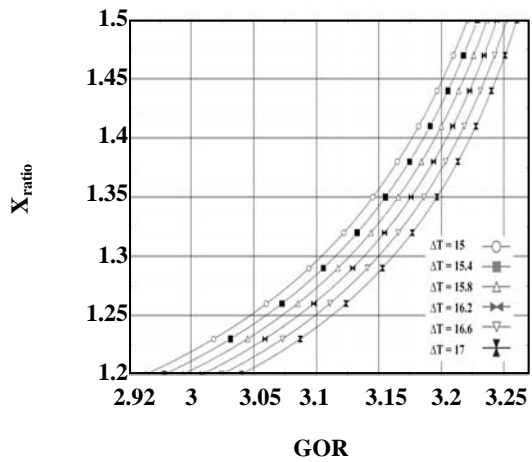

Fig. 2: Variation of GOR and  $X_{ratio}$  with  $\Delta T$  (Scenario 1).

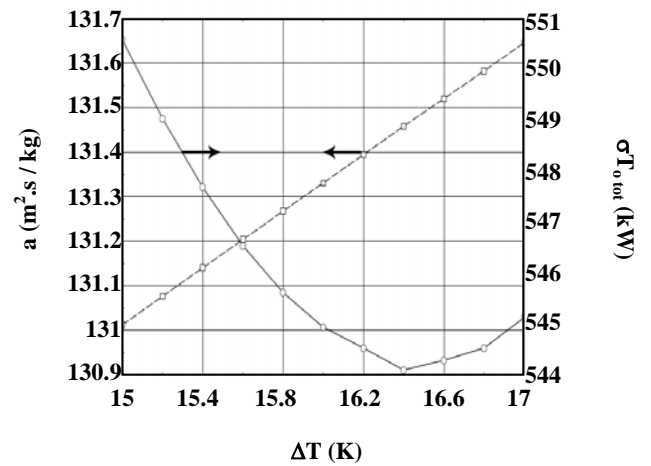

Fig. 5: Variation of  $a$  and  $\sigma T_{o\_tot}$  with  $\Delta T$  (Scenario 1).

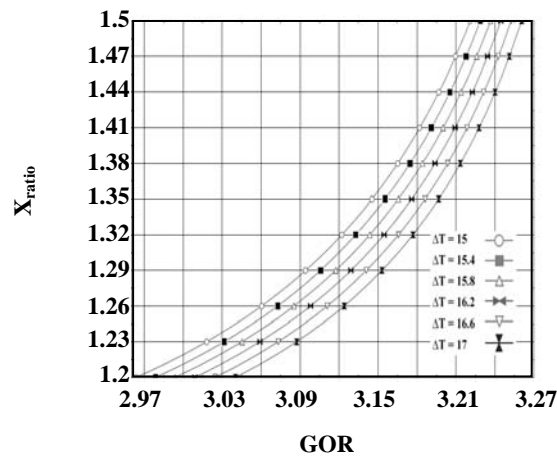

Fig. 3: Variation of GOR and  $X_{ratio}$  with  $\Delta T$  (Scenario 2).

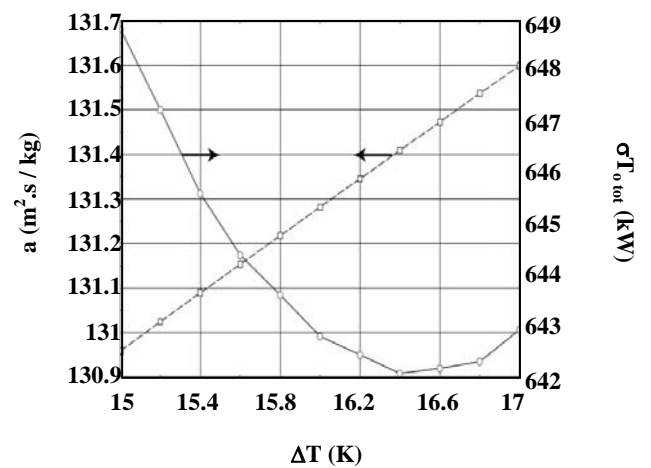

Fig. 6: Variation of  $a$  and  $\sigma T_{o\_tot}$  with  $\Delta T$  (Scenario 2).

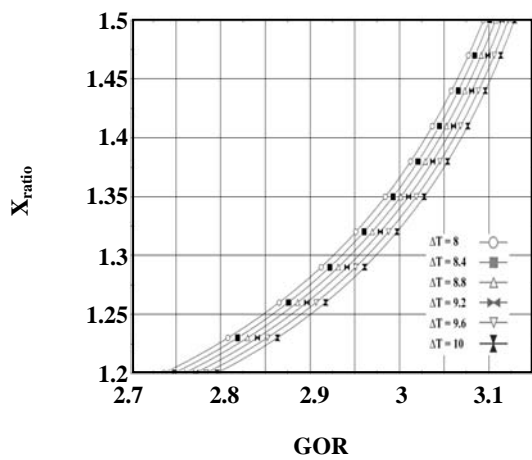

Fig. 4: Variation of GOR and  $X_{ratio}$  with  $\Delta T$  (Scenario 3).

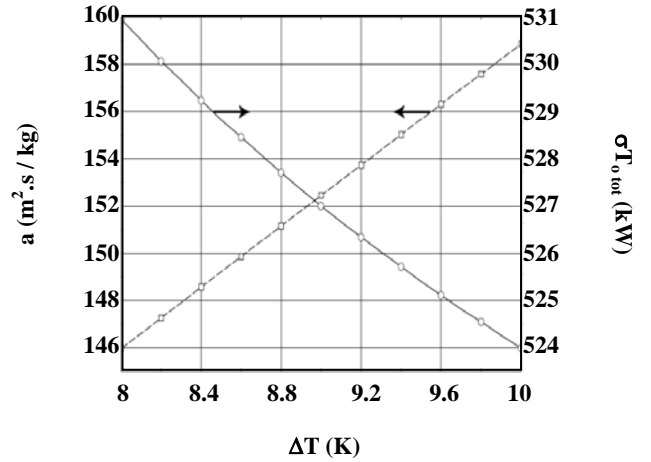

Fig. 7: Variation of  $a$  and  $\sigma T_{o\_tot}$  with  $\Delta T$  (Scenario 3).

Table 5: Assumed constraints for optimizing the objective function.

Term	Symbol	Scenario 1		Scenario 2		Scenario 3	
		minimum	maximum	minimum	maximum	minimum	maximum
Temperature difference between effects	$\Delta T$	15	17	15	17	8	10
Temperature of the second effect	$T_2$ (K)	324	328	324	328	330	334
The pre-heater temperature	$T_{H}$ (K)	330	334	330	334	324	328
Rejected brine concentration of the first effect	$X_{brj}$ (ppm)	64260	64280	64260	64280	64260	64280

The GOR increased in a constant concentration ratio by increasing  $\Delta T$ . Furthermore, decrease of  $\Delta T$  causes higher concentration ratio in a constant GOR.

#### Variation of Total exergy destruction and Specific heat transfer area with $\Delta T$

Variation of total exergy destruction and specific heat transfer area with temperature difference between effects ( $\Delta T$ ) has been investigated on the next step. According to analysis, steam jet ejector has devoted the highest amount of exergy destruction and the cost of this lost opportunity term is more considerable.

Combined graphs including trade-off between total exergy destruction and specific heat transfer area for three scenarios presented in Figs. 5, 6 and 7, respectively. According to mentioned graphs, by increasing  $\Delta T$ , specific heat transfer area as the capital investment cost reduced, but total exergy destruction as the operating cost would be increased vice-versa. The cross point on which  $\Delta T$  on-request could found out is a trade-off expression for minimum total cost.

#### Economical optimization model results

Assumed constraints for optimizing the objective function for each scenario are been listed in Table 5. The model solved by the Non-Linear mathematical Programming (NLP) method. Conclusions for three scenarios economical values are been presented in Table 6. According to acquired results, for the third scenario, the unit production cost is the most appropriate and the selected scenario for integrating is the third one.

#### CONCLUSIONS

This research objective is to select the best scenario between three recommended scenarios for a dual-purpose system by minimum unit product cost considerations. To cover the aim on this research developed codes for

simulation and optimization models has been implemented in EES and GAMS software, respectively.

In addition to cover the aim on this research, each scenario has been investigated by quantitative – qualitative and energy – cost trade off approach. By done approaches, appropriate temperature difference between effects for better conditional situation found out.

Based on simulation results, it concluded that the thermal desalination unit total exergy destruction for the third scenario equal to 529.6 kW is the lowest term among three scenarios.

Regarding to optimization results, it concluded that the unit production cost for the third scenario equal to 2.59 \$/m<sup>3</sup> is the optimum one among three scenarios.

#### Nomenclature

a	Specific heat transfer area, m <sup>2</sup> /kg/s
A	Heat transfer area, m <sup>2</sup>
AC	Air Compressor
B	Brine blow down mass flow rate, kg/s
BPE	Boiling point elevation, °C or K
C <sub>ac</sub>	Annual capital cost, \$
C <sub>aS</sub>	Annual HRSG steam production cost, \$/yr
C <sub>at</sub>	Cost of total surface area, \$
C <sub>c</sub>	Total capital cost, \$
CC	Combustion Chamber
C <sub>ch</sub>	Chemical cost, \$/yr
C <sub>co</sub>	Construction cost, \$
C <sub>d</sub>	Direct capital cost, \$
C <sub>el</sub>	Unit product electric cost, \$/kWh
C <sub>em</sub>	Contingency cost, \$
C <sub>eq</sub>	Equipment cost, \$
C <sub>f</sub>	Fuel cost, \$/m <sup>3</sup>
C <sub>fr</sub>	Freight cost, \$
C <sub>i</sub>	Indirect capital cost, \$
C <sub>in</sub>	Insurance cost, \$
C <sub>l</sub>	Land cost, \$



Table 6: Three scenarios optimization results.

Descriptions	Scenario 1	Scenario 2	Scenario 3
Equipment cost, $C_{eq}$ (\$)	277770	277770	272740
Side development cost, $C_{sd}$ (\$)	55555	55555	54549
Land cost, $C_l$ (\$)	0	0	0
Direct capital cost, $C_d$ (\$)	333325	333325	327289
Freight cost, $C_{fr}$ (\$)	16666	16666	16365
Construction overhead cost, $C_{co}$ (\$)	41666	41666	40912
Owners cost, $C_{ow}$ (\$)	27777	27777	27274
Contingency cost, $C_{em}$ (\$)	33333	33333	32729
Indirect capital cost, $C_i$ (\$)	119442	119442	117280
Annual capital cost, $C_{ac}$ (\$/yr)	72335	72335	71025
Pumping cost, $C_p$ (\$/yr)	69225	69225	62283
Labor cost, $C_{lb}$ (\$/yr)	7883	7883	7478
Chemical cost, $C_{ch}$ (\$/yr)	3153	3153	2991
Maintenance and spare parts cost, $C_m$ (\$/yr)	1447	1447	1421
Insurance cost, $C_{in}$ (\$/yr)	362	362	355
Exergy lost opportunity cost, $C_{\sigma To}$ (\$/yr)	42919	61899	47576
Thermal energy cost, $C_T$ (\$/yr)	249960	-	-
Annual HRSG steam production cost, $C_{as}$ (\$/yr)	-	761	761
Annual operating cost, $C_{op}$ (\$/yr)	374949	143969	122104
Total annual cost, $C_{tot}$ (\$/yr)	447284	217065	193890
Total annual distillate product ( $m^3$ /yr)	78950	78950	74561
Unit product cost, $UPC$ (\$/ $m^3$ )	5.66	2.75	2.59

$C_{lb}$	Labor cost, \$/yr	FB	Flashing Box
$C_m$	Maintenance and spare parts cost, \$	FC	Fuel Compressor
$C_{op}$	Operating cost, \$	GAMS	Generalized Algebraic Modeling System
$C_{ow}$	Owner cost, \$	GOR	Gain output ratio
$C_p$	Pumping cost, \$/yr	GT	Turbine
$C_s$	HRSG steam production cost, \$/ton	h	Specific enthalpy, kJ/kg
$C_{sd}$	Site development cost, \$	HRSG	Heat recovery steam generator
$C_T$	Thermal energy cost, \$/yr	i	Interest rate
D	Distillate, kg/s	k	Specific chemical cost, \$/ $m^3$
DT	Distillate Tank	kW	Kilowatt
E	Pumping, kW	kWh	Kilowatt hour
EES	Engineering Equation Solver	L	Latent heat, kJ/kg
Ex	Specific exergy, kJ/kg	LHV	Low heat value, kJ/kg
f	Plant load factor	LMTD	Logarithmic mean temperature difference
F	Mass flow rate of feed seawater, kg/s	m	Mass flow rate, kg/s

METVC	Multi-effect thermal vapor compression
MIW	Megawatt
n	Number of years
p	Power output, MW
P	Pressure, MPa
ppm	parts per million
Q	Heat, kW
$R_{pw}$	Power to water ratio, kJ/kg
s	Specific entropy, kJ/kg.K
SHC	Specific heat capacity, kJ/kg.K
SJE	Steam Jet Ejector
T	Temperature, °C or K
TBT	Top brine temperature, °C or K
TDU	Thermal Desalination Unit
U	Heat-transfer coefficient, kW/m <sup>2</sup> .K
UPC	Unit product cost, \$/m <sup>3</sup>
w	Entrained ratio
X	Salinity of saline water, ppm
y	Flashing fraction
Z	Amortization factor
a	Air
an	Annual
br	Rejected brine
c	Condenser
cool	Rejected cooling seawater
D	Distillate
e	Evaporator
el	Electricity
f	Fuel
F	Feed seawater
g	Gross
hs	Heating steam
l	Liquid
n	Number of effects
net	Net production
o	Surroundings
p	Pumping
ph	Pre-heater
r	Entrained steam
rec	Recovered
s	Motive steam
t	Thermal
tot	Total
sw	Seawater
v	Vapor

**Greek symbols**

$\alpha$	Specific cost of operating labor, \$/m <sup>3</sup>
$\beta$	Avoidable exergy destruction coefficient
$\eta_t$	Thermal efficiency of thermal cycle, %
$\sigma T_o$	Exergy destruction, kW
$\Delta T$	Temperature difference between effects, °C or K

Received : Aug. 16, 2011 ; Accepted : Mar. 6, 2012

**REFERENCES**

- [1] Wand Y., Lior N., Performance Analysis of Combined Humidified Gas Turbine Power Generation and METVC Desalination Systems - Part 1, *Desalination*, **196**, p. 84 (2006).
- [2] Shakouri M., Ghadamian H. , Sheikholeslami R., Optimal Model for Multi effect Desalination System Integrated with Gas Turbine, *Desalination*., **260**, p. 254 (2010).
- [3] Klein S.A., Alvarado F.L., "Engineering Equation Solver (EES) User Manual", F-Chart Software, 4406 Fox Bluff Rd, Middleton, WI 53562, (1999).
- [4] Rosenthal R.E., "GAMS A User's Guide", GAMS Development Corporation, Washington, DC, USA, (2008).
- [5] Alasfour F.N., Darwish M.A., Bin Amer A.O., Thermal Analysis of ME-TVC+MEE Desalination Systems, *Desalination*, **174**, p. 39 (2005).
- [6] El-Dessouky H.T., Ettouney H.M., "Fundamentals of Salt Water Desalination", ELSEVIER, Amsterdam, Netherlands, (2002).
- [7] El-Dessouky H.T., Ettouney H.M., Al-Juwayhel F., Multiple Effect Evaporation-Vapor Compression Desalination Processes, *Trans IChemE*, Part A, **78**, p. 662 (2000).
- [8] Choi Hyun-Sung, Lee Tae-Jin, Kim Yang-Gyn, Song Seok-Lyong, Performance Improvement of Multiple-Effect Distiller with Thermal Vapor Compression System by Exergy Analysis, *Desalination*, **182**, p. 239 (2005).
- [9] Alasfour F.N., Bin Amer A.O., The Feasibility of Integrating ME-TVC+MEE with Azzour South Power Plant: Economic Evaluation, *Desalination*, **197**, p. 33 (2006).